

Version 1.2

2010.03.04

Service Guide

Drum Washing Machine

Model : DWD-WD125*

DWD-WD135*

DWD-WD135*02

DAEWOO

✓ Caution

: In this Manual, some parts can be changed for improving, their performance without notice in the parts list. So, if you need the latest parts information, please refer to PPL(Parts Price List) in Service Information Center (<http://svc.dwe.co.kr>).

DAEWOO 
ELECTRONICS

DRUM WASHING MACHINE SERVICE GUIDE

■ What is Drum Washing machine	2
■ Product Spec.....	5
■ Operating Mechanism Diagram	6
■ Parts list for each Assy.....	7
■ Control Part Function Spec.	19
■ PCB Pin Arrangement	44
■ Electronic Parts List Spec.	45
■ Power Defect.....	59
■ Noise Defect.....	60
■ Wirng Diagram	61
■ Installation	62
■ Reversing the door.....	64
■ Dismantling method per washer ass'y	66

■ What is Drum Washing Machine?

1. Drum Washing Machine

Water consumption is reduced by using the power of the laundry falling (free-fall) created when rotating the drum resembling a sieve net. With temperature control system, this drum washing machine saves energy and improves washing performance at the same time.

2. Features of Drum Washing Machine

※ Note that some features are options.

◆ Simultaneous supply of cold · hot water

As cold and hot water is supplied at the same time, heating time and energy is saved.

◆ Top-quality popup dial

The top-quality popup dial is used only during washing process.

◆ Dust filter

Filter to remove foreign substances, such as naps generated during washing, etc., is installed inside the drum.

◆ DD inverter motor

The direct-drive type, of which motor is directly connected to drum without an interim clutch, significantly reduces noise and vibration.

◆ Heating device is installed to enable boiling of the laundry.

◆ Large door creates grand appearance and makes it easy to put in and out the laundry.

◆ For pump drainage, the powerful pump speeds up drainage process.

3. Power System

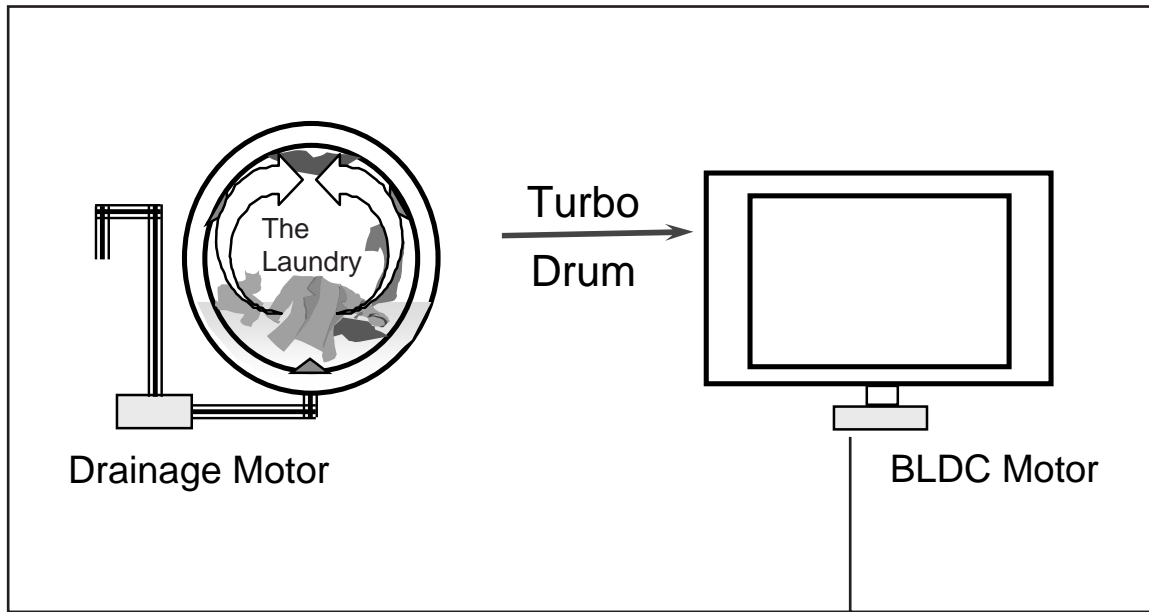

- DD Control: Direct drive type of direct connection between drum and motor
- Rotation by powerful high-performance BLDC motor
- Pump drainage type for built-in installation

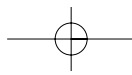

4. Major Functions of Drum Washing Machine

① Washing

When rotating drum after putting in the laundry and detergent into the drum, the laundry are rotated by protrusions (lifters) attached inside the drum.

Washing is carried out with bending and impact actions generated by falling of the laundry to the top part of drum.

② Rinsing

Rinsing cleanly washes out detergent and dirt removed from the laundry after washing cycle.

③ Spin-drying

Weak, standard and strong cycles can be selected according to types of fabrics to be washed. Spin-drying is carried out by rotation (the centrifugal force) of drum according to the designated speed.

④ Drainage

Pump Drainage: Powerful pump for built-in installation and application of filter to remove foreign substances

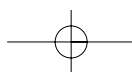

Product Spec

Product Spec.

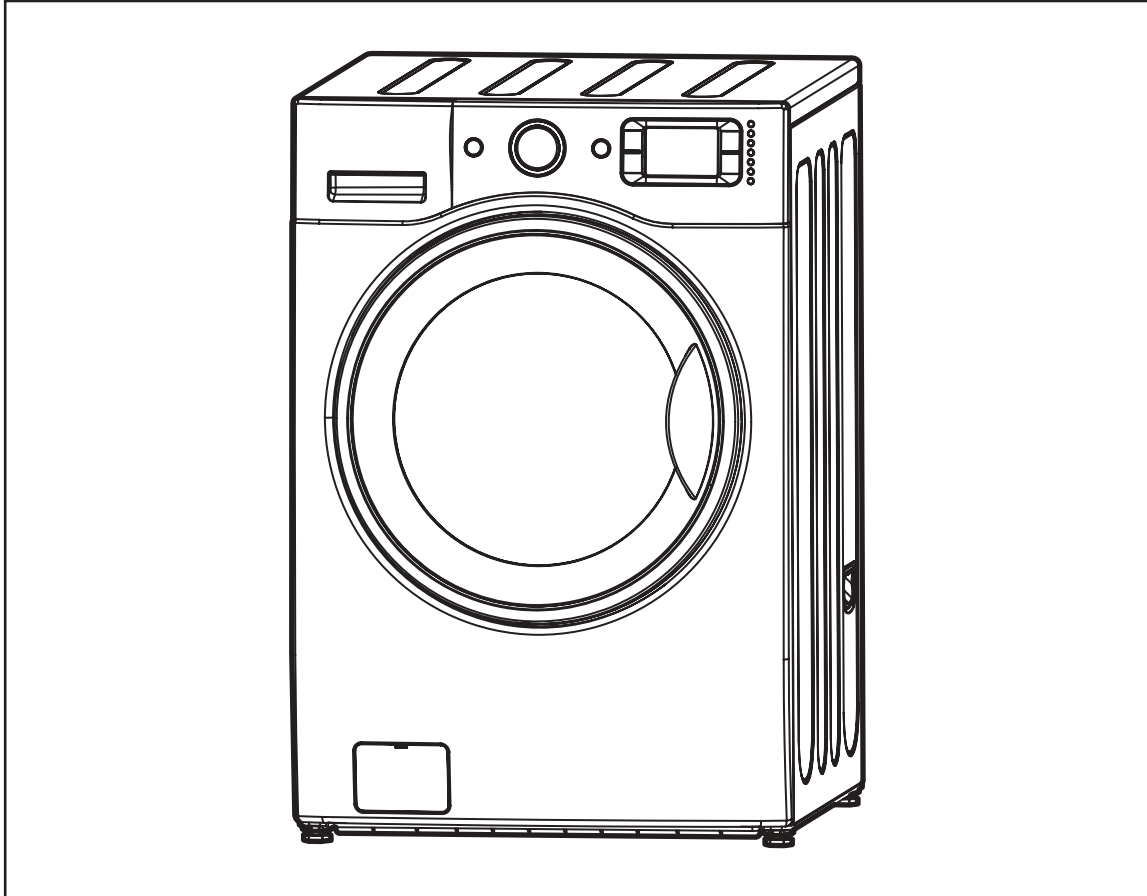

MODEL	DWD-WD125*	DWD-WD135*	DWD-WD135*S
Dimension (inches)	27 x 31.8 x 40.1 (W x D x H) (Door open D : 40.9)		
Unit Weight (lbm)	198.4(Net) / 227(Gross)		
Wash capacity	3.92 cu.ft. DOE, 4.5 cu.ft. IEC, 10.4kg		
Spin Speed (RPM)	1200 rpm max.	1300 rpm max.	
Operating Water Pressure	4.5~145 PSI (30~1000 kPa)		
Electrical Spec.	120V / 60Hz, 10 A		
Option Spec	X	X	Steam(900W)

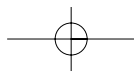

Operating Mechanism Diagram

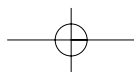
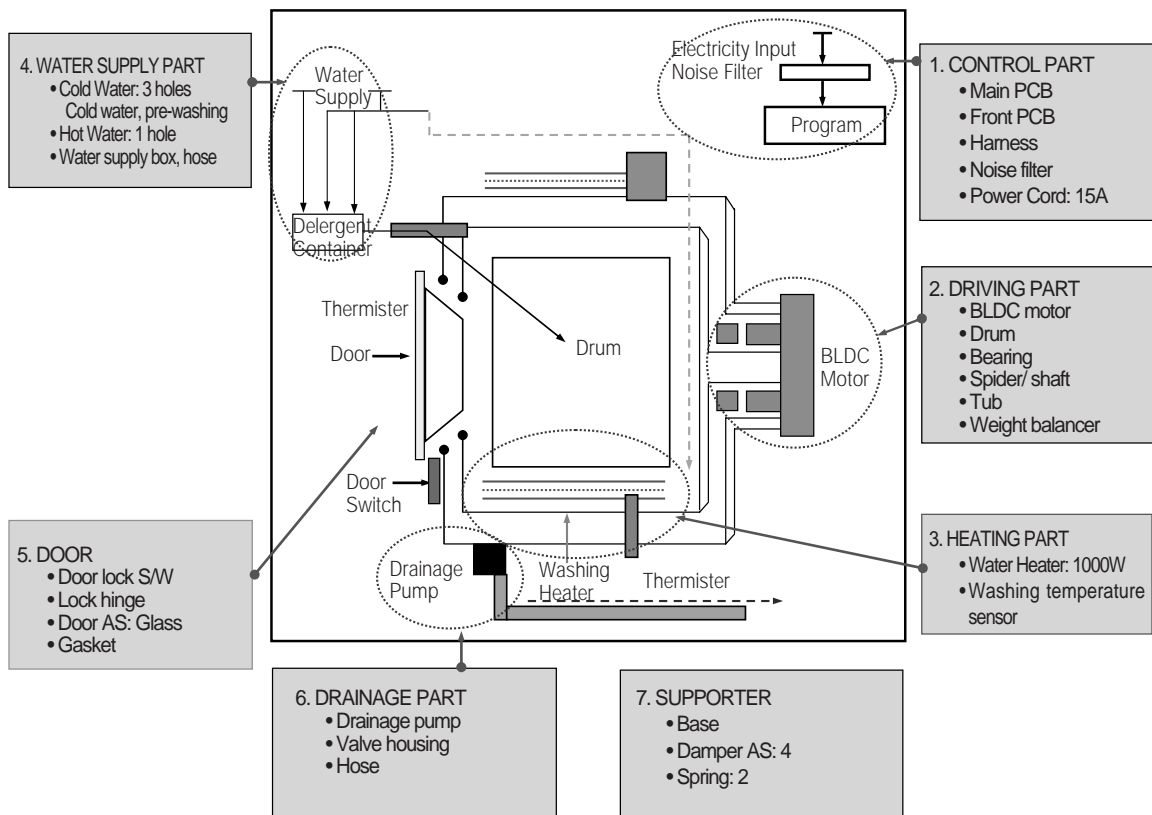

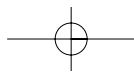

■ PARTS LIST FOR EACH ASSY

1. CABINET AS

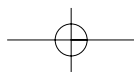
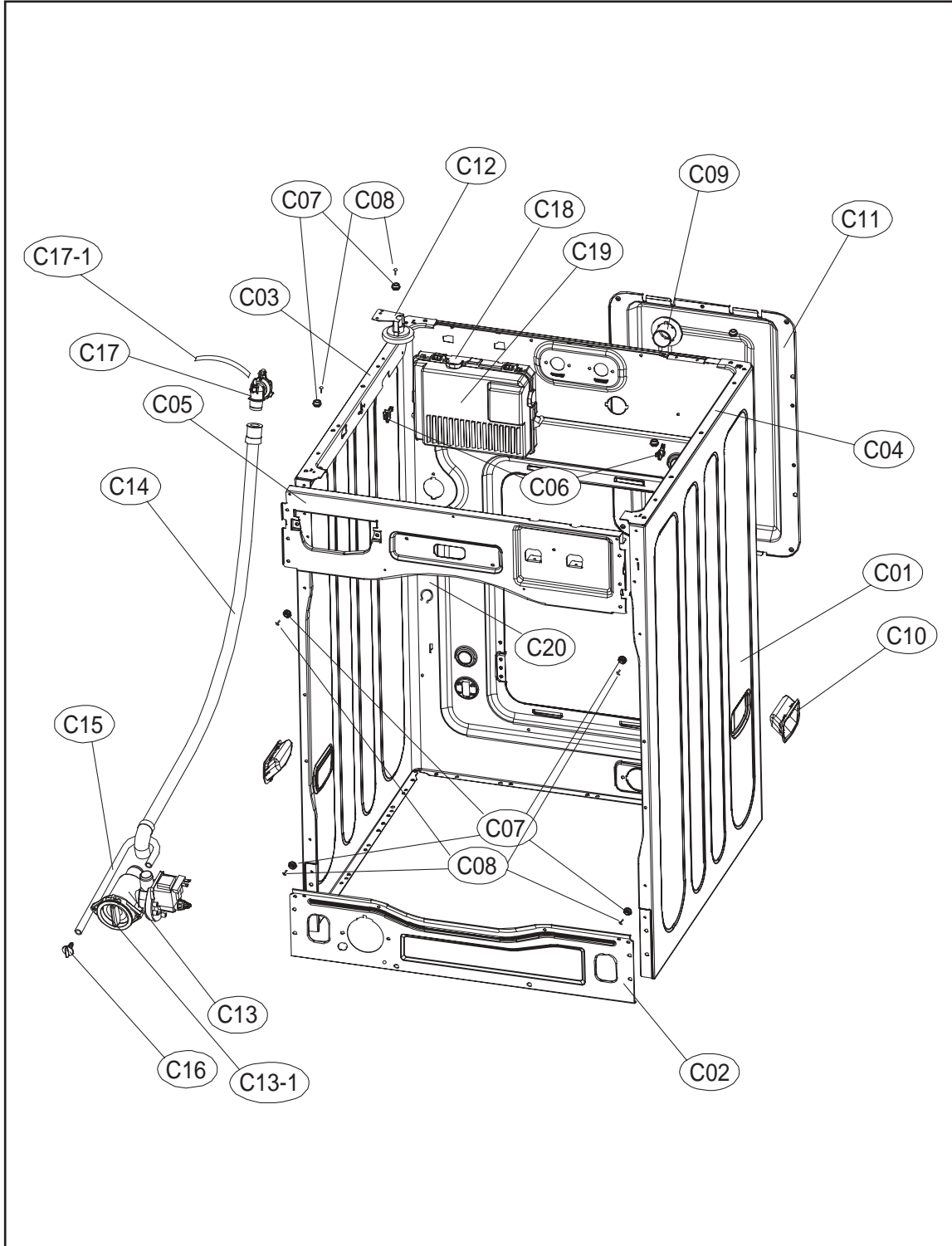

No.	Part Name	Part Code	Qty	Specification	Remark
-	CABINET SUB AS	3610811950	1	13KG, PUMP, WHITE	
		3610811955	1	13KG, PUMP, PLATINUM	
		3610811956	1	13KG, PUMP, ROSE RED	
C01	CABINET	3610811740	1	SGCC 0.8T PUMP WASHER	• 1PIECE SVC PART => CABINET SUB AS
C02	FRAME LOWER	3612206700	1	SBHG 1.2T	
C03	FRAME TOP L	3612206500	1	SGCC 1.6T	
C04	FRAME TOP R	3612206600	1	SGCC 1.6T	
C05	FRAME UPPER	3612208200	1	SGCC 1.2T	
-	SCREW TAPPING	7122401411	6	T2S TRS 4 x 14 MFZN	Fix Frame Upper to Cabinet
C06	STOPPER SPRING	3615202200	2	POM	
C07	FIXTURE PLATE	3612008000	8	POM	
C08	SCREW TAPPING	7121401211	8	T2S PAN 4 x 12 MFZN	
C09	NOZZLE AIR	3618103110	1	PP	
C10	HANDLE CABINET	3612608100	2	PP, WHITE	
			2	PP, PLATINUM, RED	
C11	COVER BACK AS	3611425530	1	COVER B + PAD + LABEL	
-	SCREW TAPPING	7122401411	4	T2S TRS 4 x 14 MFZN	Fix Cober Back to Cabinet
C12	SENSOR PRESSURE	3614825220	1	DWD-130RP	
-	SCREW TAPPING	7122401411	2	T2S TRS 4 x 14 MFZN	Fix Sensor Pressure to Cabinet
C13	UNIT DRAIN PUMP AS	36189L5600	1	UL.PLASET + HANYU AS 80W	
C13-1	FILTER PUMP	3611910200	1	HANYU FILTER	
-	SCREW TAPPING	7122401411	2	T2S TRS 4 x 14 MFZN	Fix Drain Pump to Frame Lower
C14	HOSE DRAIN I	3613271300	1	ST+EL, 1010MM	
-	ABSORBER HOSE DRAIN	3610115600	1	T10, 60 x 130	
-	CLAMP HOSE	3611203900	2	SK5 D=26	Fix Drain I
C15	HOSE WATER REMAIN	3613272210	1	EPDM, UL 3T Round Bending	
C16	CAP WATER REMAIN	3610916800	1	PP	
C17	CUFF DRAIN HOSE	3616802600	1	PP, PUMP	
C17-1	HOSE SIPHON	3613272210	1	EPDM, UL 3T L=270	
-	SCREW TAPPING	7122401411	1	T2S TRS 4 x 14 MFZN	Fix Drain Hose to Cabinet
C18	PCB INVERTER AS	3610PCBF11	1	DWD-WD103*01, DWD-WD113*01	DWD-WD125*
		PRPSSWAD0E	1		
		3610PCBF06	1	M_PCB+HAR+WIRE	DWD-WD135*
		PRPSSWAD14	1		
		3610PCBF07	1	M_PCB+HAR+WIRE	DWD-WD135*02
		PRPSSWAD1F	1		
C19	COVER PCB M	3611427700	1	UL,ABS VE-0856, MAIN PCB	
C20	HARNESS AS	3612796T00	1	UL, 13K Washer, Non-bubble	~20091228(Changed)
		3612796T01	1	UL 13KG WASHER 3RD-PANEL(BLEACH), NEW MOTECH	
-	SCREW TAPPING	7122401411	1	T2S TRS 4 x 14 MFZN	Fix PCB Main to Cabinet
-	LOCK HARNESS M	3613802300	6	M Type(18 x 18), Nylon66	Cabinet rear
-	LOCK HARNESS	3613802100	2	DASTL-20NA	Frame Top right
-	LABEL WIRING UL	3613557100	1	UL Only, Wiring diagram+Warning	English&French
-	SCREW TAPPING	7122401411	1	T2S TRS 4 x 14 MFZN	Fix Cabinet F to Frame Lower

2. BASE U AS

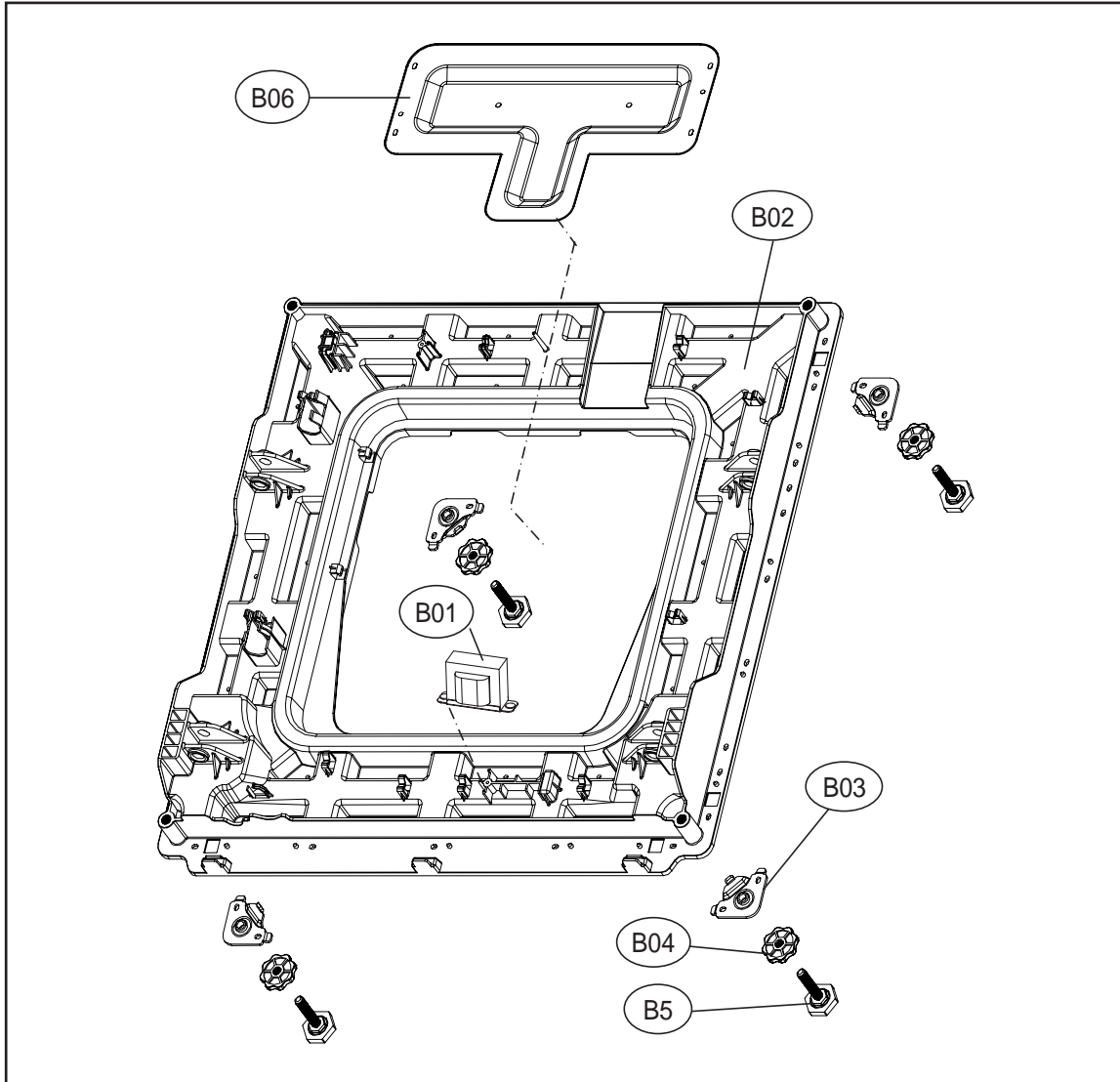

No.	Part Name	Part Code	Qty	Specification	Remark
B01	REACTOR	52G043A110	1	RT-047(U), L=150	
B02	BASE U	3610392700	1	PP	
B03	SUPPORTER LEG	3615303600	4	PO+Coating 3.0T	
B04	FIXTURE LEG	3612006400	4	ABS, DWD-100DR	
B05	FOOT AS	3612100700	4	Foot+Special bolt, Double insert type Hybra-Nylon66	
B06	PROTECTOR HEATER	3618304600	1	SECC 0.35T	
-	SCREW TAPPING	7122401411	4	T2S TRS 4x14 MFZN	Fix Protector Heater to Base U
-	SCREW TAPPING	7122401411	20	T2S TRS 4x14 MFZN	Fix Base U to Cabinet

3. TUB AS

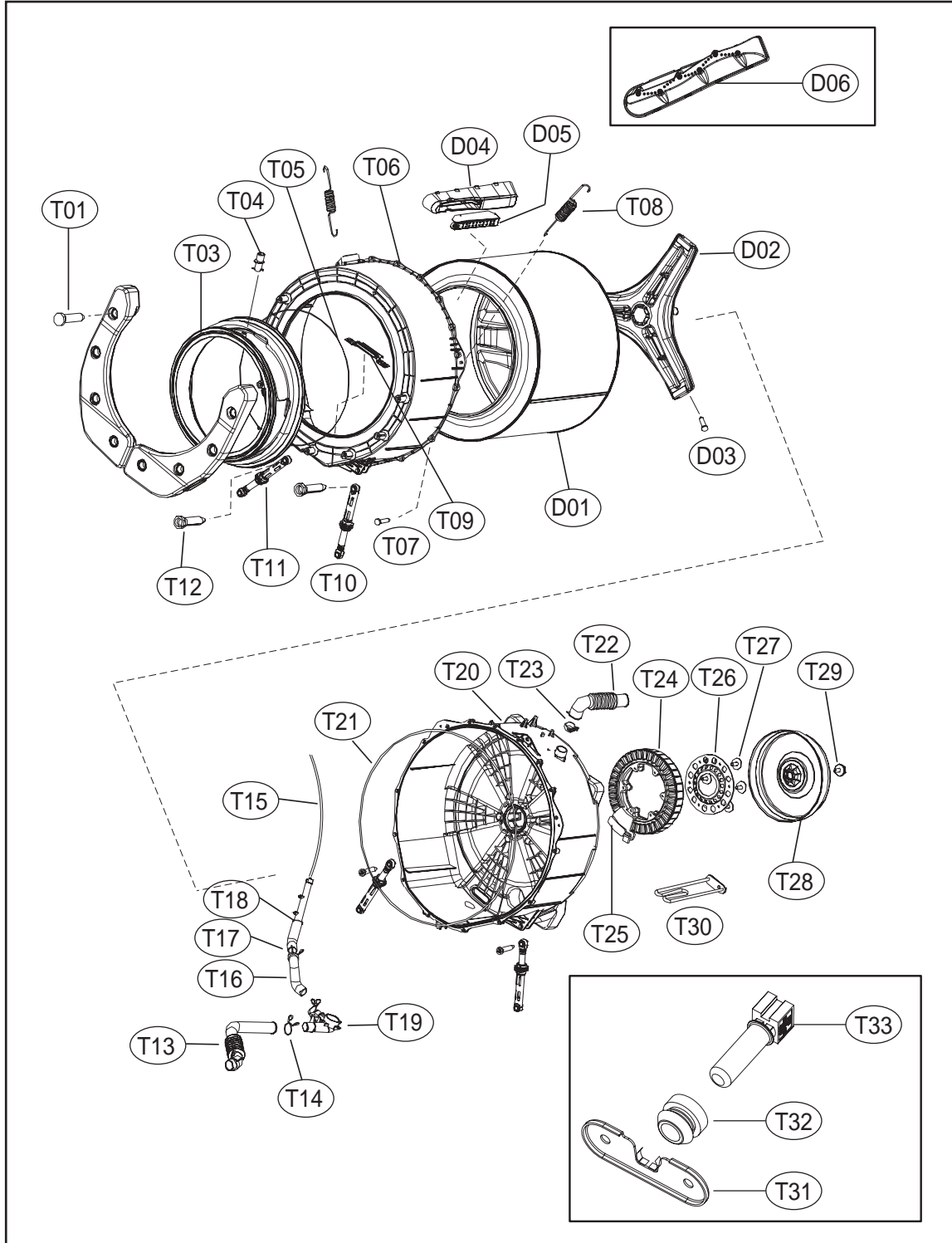

No.	Part Name	Part Code	Qty	Specification	Remark
T01	SPECIAL SCREW	3616029400	8	SWCH 8.5 x 30	Fix Balancer W. to Tub F
T02	BALANCER WEIGHT AS(L)	3616110100	1	13kg DRUM	
	BALANCER WEIGHT AS(R)	3616110200	1	13kg DRUM	
T03	GASKET AS	3612322000	1	EPDM, Wash-only, Nozzle shower	
T04	NOZZLE SHOWER	3618104000	1	PP	
T05	CLAMP GASKET AS	3611205300	1	Gasket, 13kg Drum	
T06	TUB FRONT	3618828Y00	1	FRPP, 13kg Drum	
T07	SPECIAL SCREW(TUB)	3616029800	15	SWCH 6.5 x 30	Fix Tub F & R
T08	SPRING SUSPENSION	3615114800	2	13kg DRUM	
T09	FIXTURE HEATER	3612006700	1	STS 430	
T10	DAMPER FRICTION	361A700300	2	AWECO, HP3 60N/9MM BUFFER 4,0	Tub F & R right
T11	DAMPER FRICTION	361A700110	2	70N AKS ST=170-260 DL=197.5 LOW NOISE	Tub F & R left
T12	DAMPER PIN	361A700200	8	AKS D=14.5	Tub & Base U
T13	HOSE DRAIN	3613269000	1	EPDM,PUMP	
T14	CLAMP HOSE	3611203410	2	SK5, D=33	
T15	HOSE AIR PRESSURE	3613270600	1	ID=4,OD=8,L=1000MM	
T16	HOSE AIR TRAP	3613269700	1	EPDM, 13kg Drum	
T17	CLAMP HOSE	3611204700	2	D26	
T18	AIR TRAP	361A500101	1	PP	
T19	DRAIN HOUSING I	36196TAM00	1	PP,PUMP	1 PIECE SVC PART
T20	TUB REAR AS	36100E2W00	1	DWD-WD113*, DWD-WD123*	
T21	GASKET TUB	3612322100	1	EPDM FORM, 13KG DRUM	
T22	HOSE AIR	3613266300	1	EPDM, DWD-100DR	
T23	CLAMP HOSE	3611203400	2	SK5, MFZN,D=35	
T24	UNIT ROTOR BLDC	36189L4840	1	30T,36SLOT,2SENSOR,WS2A30G011	~ 20091228(changed)
		36189L6220	1	AL,DON1400W 32T 36POLE,NMT,PET	20091228 ~
T25	HALL IC HOLDER AS	3426D01002	1	DRUM STATOR PCB HOLDER AS(SVC)	~ 20091228(changed)
		3616D01000	1	DRUM STATOR PCB HOLDER AS(SVC),NMT	20091228 ~
-	HARNESS SUB AS	3612796D00	1	130RP SUB HARNESS.MOTOR.HALL.W-TH	~ 20091228(changed)
		3612796D20	1	SUB HARNESS.NEWMOTECH MOTOR.HALL.W-TH	20091228 ~
T26	BRACKET HOUSING	3610609700	1	GI 2.3T	
T27	SPECIAL BOLT AS	3616063400	6	SWCH M8+SILOCK, 58MM Fix Stator & Tub R	
T28	UNIT ROTOR BLDC	36189L4900	1	MAGNET24,SERRATION,WR1238F001	~ 20091228(changed)
		36189L6300	1	DON1300W SR-FERRITE12,30~32T,NMT	20091228 ~
T30	HEATER WASH	3612801740	1	UL.120V1.0KW6.7W/SQ.SUS.1R3A515003.L/W.	DWD-WD113*, DWD-WD123*
T31	BRACKET THERMISTOR	3610610600	1	SGCC 0.8T, Non-Heater	DWD-WD103*01
T32	THERMISTOR WASH	361AAAAB20	1	UL.R80:1.704K.R25:11.981K	DWD-WD113*01
T33	PACKING THERMISTOR	3614011400	1	EPDM, Non-Heater	
D01	DRUM SUB AS	3617008X00	1	SUS, 13kg	1 PIECE SVC PART
D02	SPIDER AS	361A300600	1	13kg, ALDC+S45C	
D03	SPECIAL SCREW(SPIDER)	3616029500	6	STS 430, 8 x 25	
D04	LIFTER BODY	361A400700	3	PP, 13kg Drum	1st Lifter
D05	CAP FILTER	3610917310	3	ABS, NON-NANO, 13kg	1 PIECE SVC PART (OPTION)
	FILTER	3611908410	3	ABS, NON-NANO, 13kg	
	FILTER NET	3611908500	3	SUS, FILTER	
D06	LIFTER WASH	361A401400	3	NON-NANO, 1 PIECE TWIST	3rd Lifter

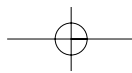

4-1 INLET BOX AS(NON-STEAM)

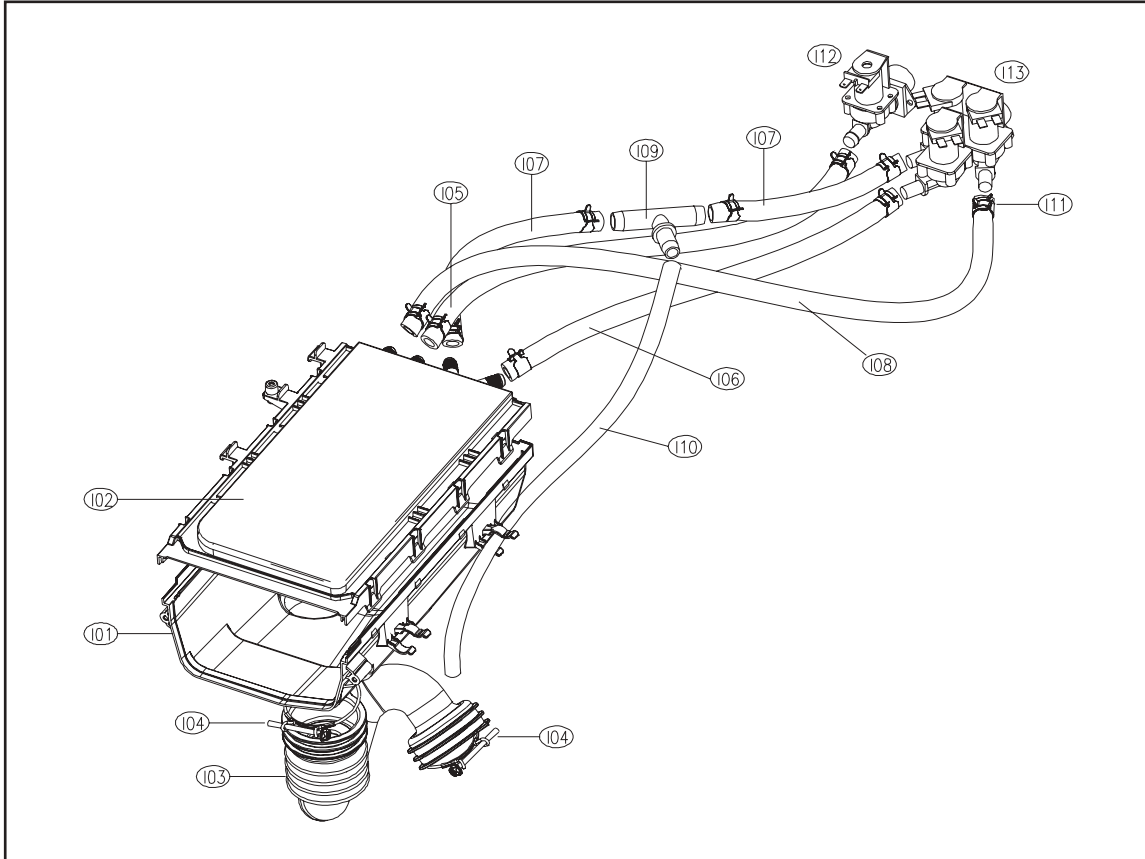

No.	Part Name	Part Code	Qty	Specification	Remark
I01	INLETBOX	3617510800	1	PP	
I02	NOZZLE AS	3618104800	1	WD1131'S, Top+Under	
I03	HOSE INLET	3613270300	1	EPDM	
I04	CLAMP AS	3611203200	2	ID=60, WIRE+GUIDE+BOLT+NUT	
I05	HOSE WATER SUPPLY	3613270920	1	EPDM ID=9.5 OD=15.5 L=410mm	From Valve Inlet to HOT nozzle
I06	HOSE WATER SUPPLY	3613270920	1	EPDM ID=9.5 OD=15.5 L=380mm	From Valve Inlet to MAIN nozzle
I07	HOSE WATER SUPPLY	3613270920	2	EPDM ID=9.5 OD=15.5 L=230mm	From Valve Inlet to PRE-WASH nozzle
I08	HOSE WATER SUPPLY	3613270920	1	EPDM ID=9.5 OD=15.5 L=530mm	From Valve Inlet to BLEACH nozzle
I09	PIPE JOINT HOSE INLET	3614413300	1	PP	
I10	HOSE SHOWER	3613270130	1	EPDM ID=8.5 L=550mm	
I11	CLAMP HOSE	3611205810	1	D-WD113'S ID14.3 W10 0.9T WH	
I12	VALVE INLET	3615416700	1	UL.120V60HZ.BITRON.1WAY	HOT
I13	VALVE INLET	3615416930	1	UL.120V60HZ.BITRON.3WAY	COLD
-	SCREW TAPPING	7002400811	4	TRS 4X8 MFZN	Fix Valve Inlet to Cabinet
-	SCREW TAPPING	7122401411	1	T2S TRS 4X14 MFZN	Fix Inletbox to Frame T(Side)

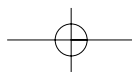

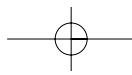

4-2 INLET BOX AS(HOT-STEAM)

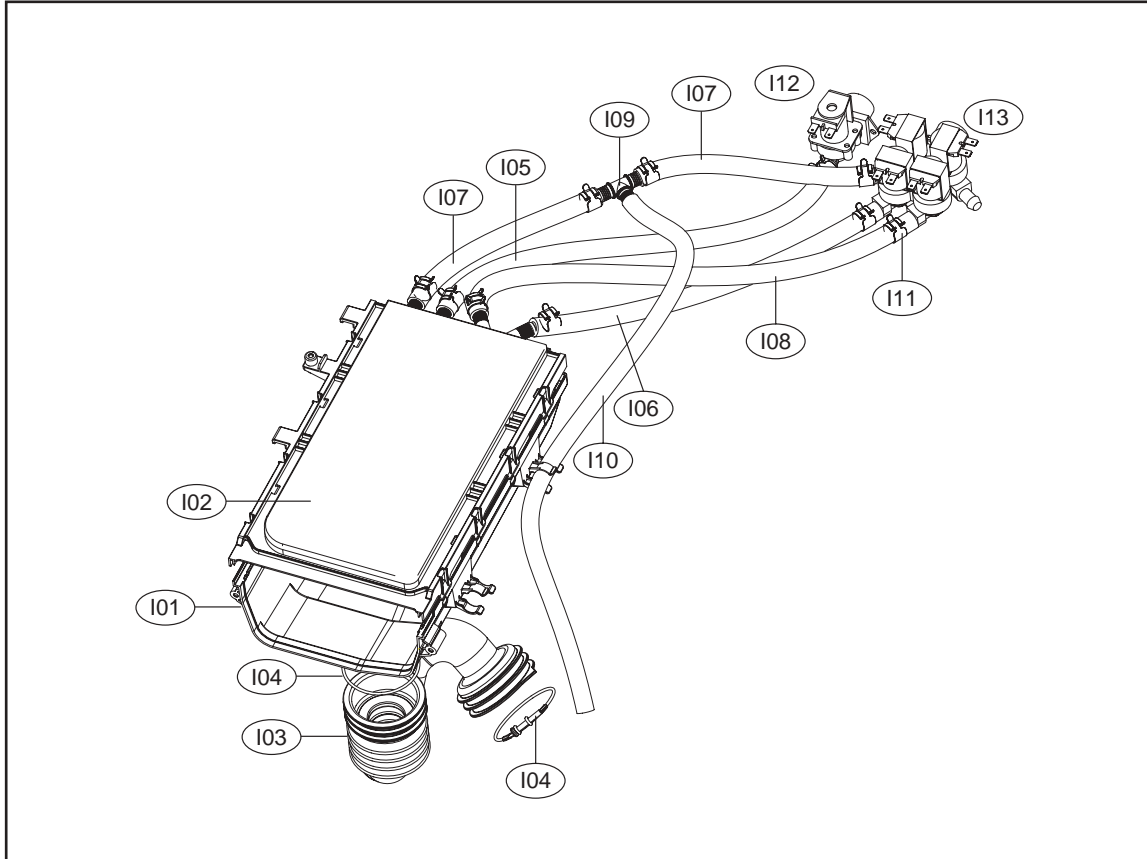

No.	Part Name	Part Code	Qty	Specification	Remark
I01	INLETBOX	3617510800	1	PP	
I02	NOZZLE AS	3618104800	1	WD1131'S, Top+Under	
I03	HOSE INLET	3613270300	1	EPDM	
I04	CLAMP AS	3611203200	2	ID=60, WIRE+GUIDE+BOLT+NUT	
I05	HOSE WATER SUPPLY	3613270920	1	EPDM ID=9.5 OD=15.5 L=410mm	From Valve Inlet to HOT nozzle
I06	HOSE WATER SUPPLY	3613270920	1	EPDM ID=9.5 OD=15.5 L=430mm	From Valve Inlet to MAIN nozzle
I07	HOSE WATER SUPPLY	3613270920	2	EPDM ID=9.5 OD=15.5 L=220mm	From Valve Inlet to PRE-WASH nozzle
I08	HOSE WATER SUPPLY	3613270920	1	EPDM ID=9.5 OD=15.5 L=350mm	From Valve Inlet to BLEACH nozzle
I09	PIPE JOINT HOSE INLET	3614413300	1	PP	
I10	HOSE SHOWER	3613270130	1	EPDM ID=8.5 L=550mm	
I11	CLAMP HOSE	3611205810	1	D-WD113'S ID14.3 W10 0.9T WH	
I12	VALVE INLET	3615416700	1	UL.120V60HZ.BITRON.1WAY	HOT
I13	VALVE INLET	3615416930	1	UL.120V60HZ.BITRON.3WAY	COLD
-	SCREW TAPPING	7002400811	4	TRS 4X8 MFZN	Fix Valve Inlet to Cabinet
-	SCREW TAPPING	7122401411	1	T2S TRS 4X14 MFZN	Fix Inletbox to Frame T(Side)

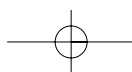

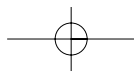

5. CABINET FRONT ASS'Y

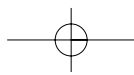
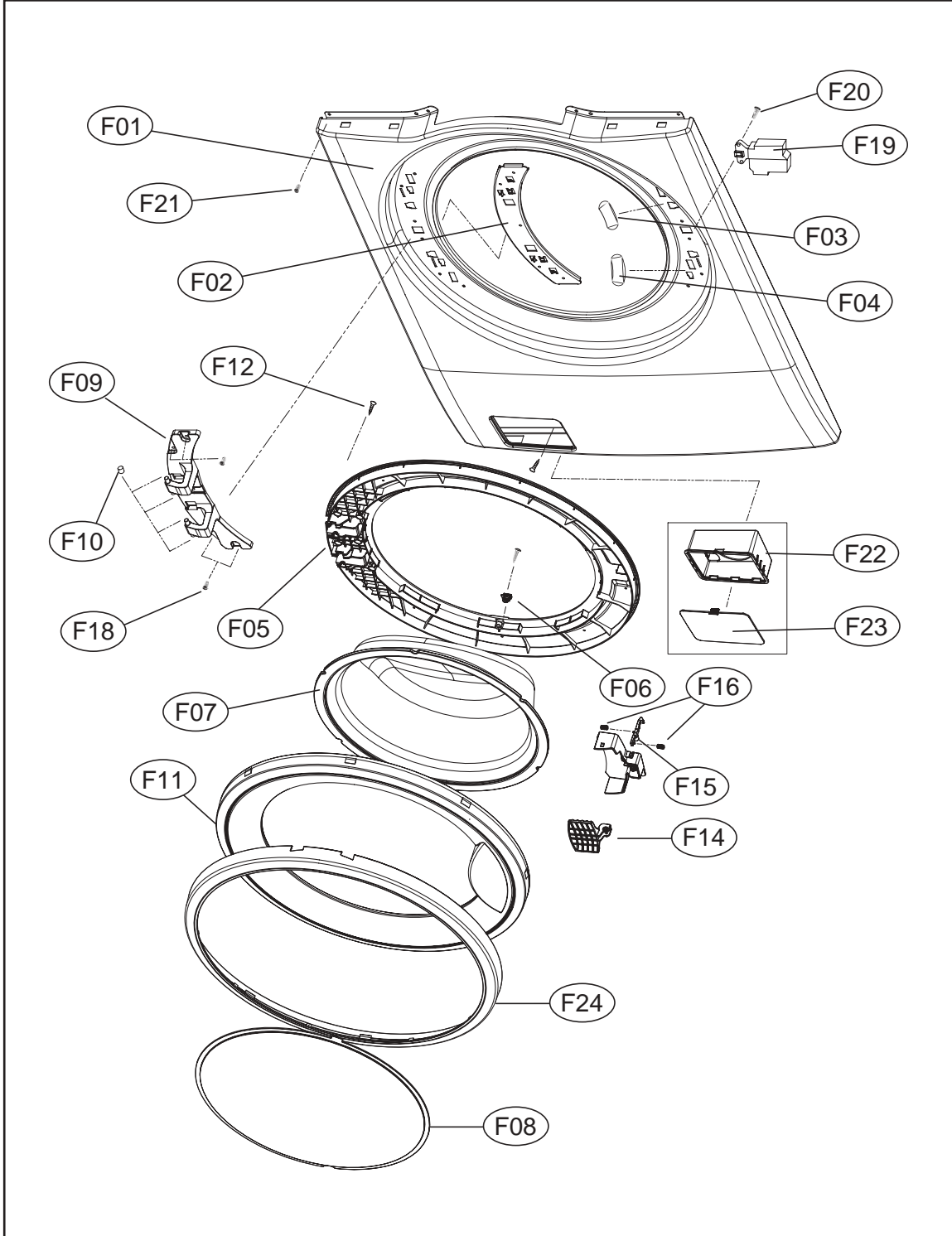

No.	Part Name	Part Code	Qty	Specification	Remark
F01	CABINET F SUB AS	3610811310	1	13KG, PUMP, WHITE	
		3610811321	1	13KG, PUMP, PLATINUM	
		3610811322	1	13KG, PUMP, ROSE RED	
F02	SUPPORTER HINGE	3615304001	1	SGCC 1.2T	
F03	LABEL SAFETY R	3613555800	1	PET, DOOR SAFETY,UL	
			1	PET, DOOR SAFETY,UL, RH	Right Handle type
F04	LABEL WARNING	3613555800	1	PET,SILVER,DOOR WARNING,UL	
			1	PET, DOOR WARNING,UL, RH	Right Handle type
F05	FRAME DOOR IN	3612210700	1	PP(Heat resisting)	
F06	STOPPER DOOR	3615202300	1	PP(Heat resisting)	
F07	DOOR GLASS	361A110600	1	GLASS	
F08	PROTECTOR GLASS	3618304300	1	ABS(Transparent)	
F09	HINGE DOOR AS	3612903900	1	13K WASHER,ALDC	
F10	CAP HINGE DOOR	3610916500	4	POM	
F11	FRAME DOOR OUT	3612210800	1	13K WASHER,ALDC	
F12	SCREW TAPPING	7115402029	16	T1S FLT 4*20 STS430 NATURAL	
F13	COVER HANDLE	3611429300	1	ABS	WHITE
F14	HANDLE DOOR	3612612100	1	ABS	
F15	HOOK DOOR	3613100800	1	ZNDC	
F16	SPRING HOOK	3615113700	2	SUS ID=4.3,NI=7,D=φ 0.9	
F17	PIN HANDLE	3618200100	1	SUS, D3.0	
F18	SCREW TAPPING	3616051229	4	STS430 F/L BOLT(SE) 5*12	
F19	SWITCH DOOR LOCK	3619046410	1	DF F11 110 125V 16A PTC-SOLENOID	
F20	SCREW TAPPING	7122401608	2	T2S TRS 4 x 16 SUS 430	For fixing Door S/W to Cabinet F
F21	SCREW TAPPING	7122401411	4	T2S TRS 4 x 14 MFZN	For fixing Cabinet F to Cabinet
F22	CASE PUMP	3611141400	1	PP	
F23	COVER PUMP	3611426800	1	ABS, WHITE	
			1	ABS, PLATINUM	
			1	ABS, RED	

6. PANEL F AS

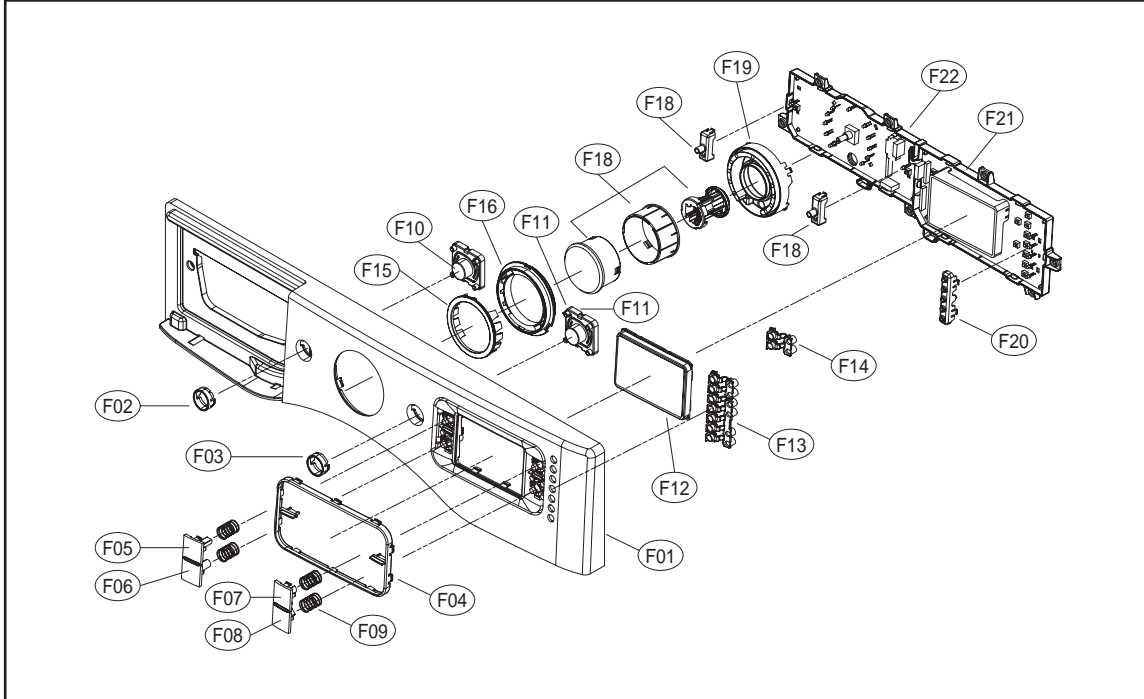

No.	Part Name	Part Code	Qty	Specification	Remark
-	PANEL-F AS	PRPAFR9Z10	1	DWD-WD1352S/1352	
F01	PANEL-F	3614289600	1	ABS + SILK Printing	
F02	DECO BUTTON POWER	3611692120	1	ABS(GILDING/SPRAY)	
F03	DECO BUTTON START	3611692220	1	ABS(GILDING/SPRAY)	
F04	DECO WINDOW	3611692420	1	ABS(GILDING/SPRAY)	
F05	BUTTON FUNCTION WASH	3616640700	1	ABS + SILK Printing	
F06	BUTTON FUNCTION SPIN	3616640800	1	ABS + SILK Printing	
F07	BUTTON FUNCTION SOIL	3616640900	1	ABS + SILK Printing	
F08	BUTTON FUNCTION BEEP	3616641000	1	ABS + SILK Printing	
F09	SPRING BUTTON	3615116200	4	SUS 0.7PI D=12.3 L=15	
F10	BUTTON POWER AS	3616640550	1	Transparent PC	
F11	BUTTON START AS	3616640650	1	Transparent PC	
F12	WINDOW DISPLAY	3615508300	1	Transparent ABS TR 558	
F13	BUTTON OPTION	3616641200	1	Transparent ABS TR 558	
F14	BUTTON TIME	3616641100	1	ABS	
F15	WINDOW COURSE	3615508200	1	Transparent ABS TR 558	
F16	DECO COURSE	3611692310	1	ABS(GILDING/SPRAY)	
F17	BUTTON DIAL AS	3616643300	1	Push-Pull Type	
F18	HOLDER POWER	3613056800	2	ABS(Anti-flammable, VE-0856)	
F19	HOLDER COURSE	3613056900	1	ABS(Anti-flammable, VE-0856)	
F20	HOLDER OPTION	3613057000	1	ABS(Anti-flammable, VE-0856)	
F21	CUSTOM LED	3610019900	1	18:88 LED	
F22	CASE PCB F	3611148800	1	ABS(Anti-flammable, VE-0856)	
-	PCB AS	PRPSSWAD36	1	DWD-WD1352S/1352	
-	SCREW TAPPING	7122401211	7	T2 TRS 4x12 MFZN	

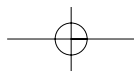

7. UNIT STEAM WASHER AS

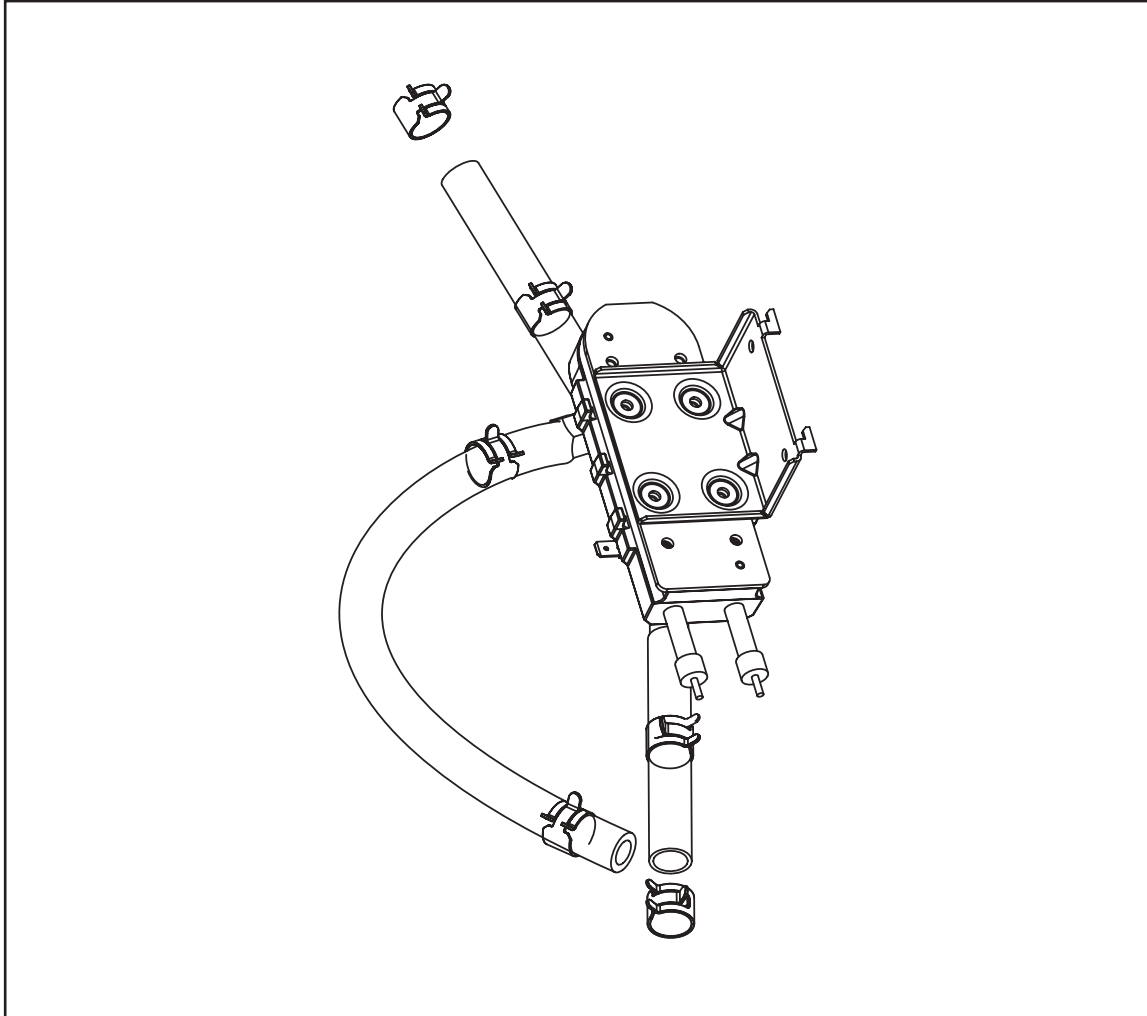

No.	Part Name	Part Code	Qty	Specification	Remark
-	UNIT STEAM WASHER AS	3619606800	1	D-WD1351,HOT STEAM AS	
S01	UNIT STEAM AS	3619606700	1	D-WD1351,STEAM AS	
S02	HOSE SPRAY	3613275100	0.245	UL, SILICON, ID=9.5, OD=16.5	
S03	HOSE SPRAY	3613275100	0.73	UL, SILICON, ID=9.5, OD=16.5	
S04	HOSE SPRAY	3613275100	0.62	UL, SILICON, ID=9.5, OD=16.5	
S05	CLAMP HOSE	3611205830	6	HOT SPRAY,ID=15.5	

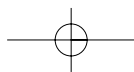

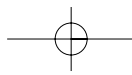

8. CASE DETERGENT AS

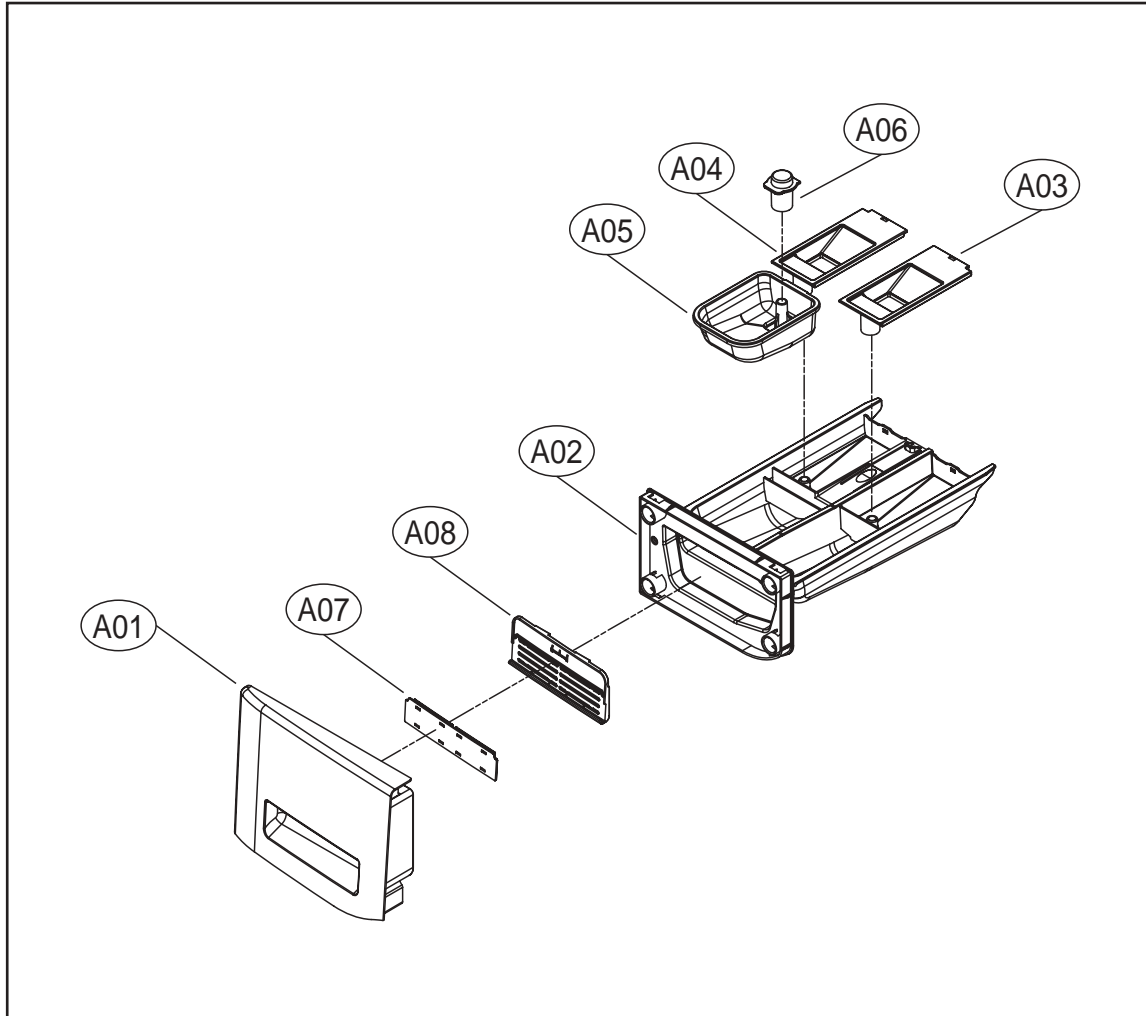

No.	Part Name	Part Code	Qty	Specification	Remark
-	CASE DETERGENT AS	3611149000	1	DWD-WD1151	
A01	CASE HANDLE	3611148700	1	ABS	
A02	CASE DETERGENT	3611145600	1	PP	
A03	CAP SOFTENER	3610917800	1	PP	
A04	CAP BLEACH	3610917900	1	PP	
A05	CASE LIQUID	3611145700	1		
A06	CAP LIQUID	3610918000	1		
A07	CUSHION HANDLE	3611571900	1	SILICON, WD1151	
A08	DECO CASE HANDLE	3611691900	1	ABS, CROM_BASE	

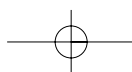

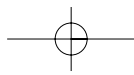

9. PLATE T AS

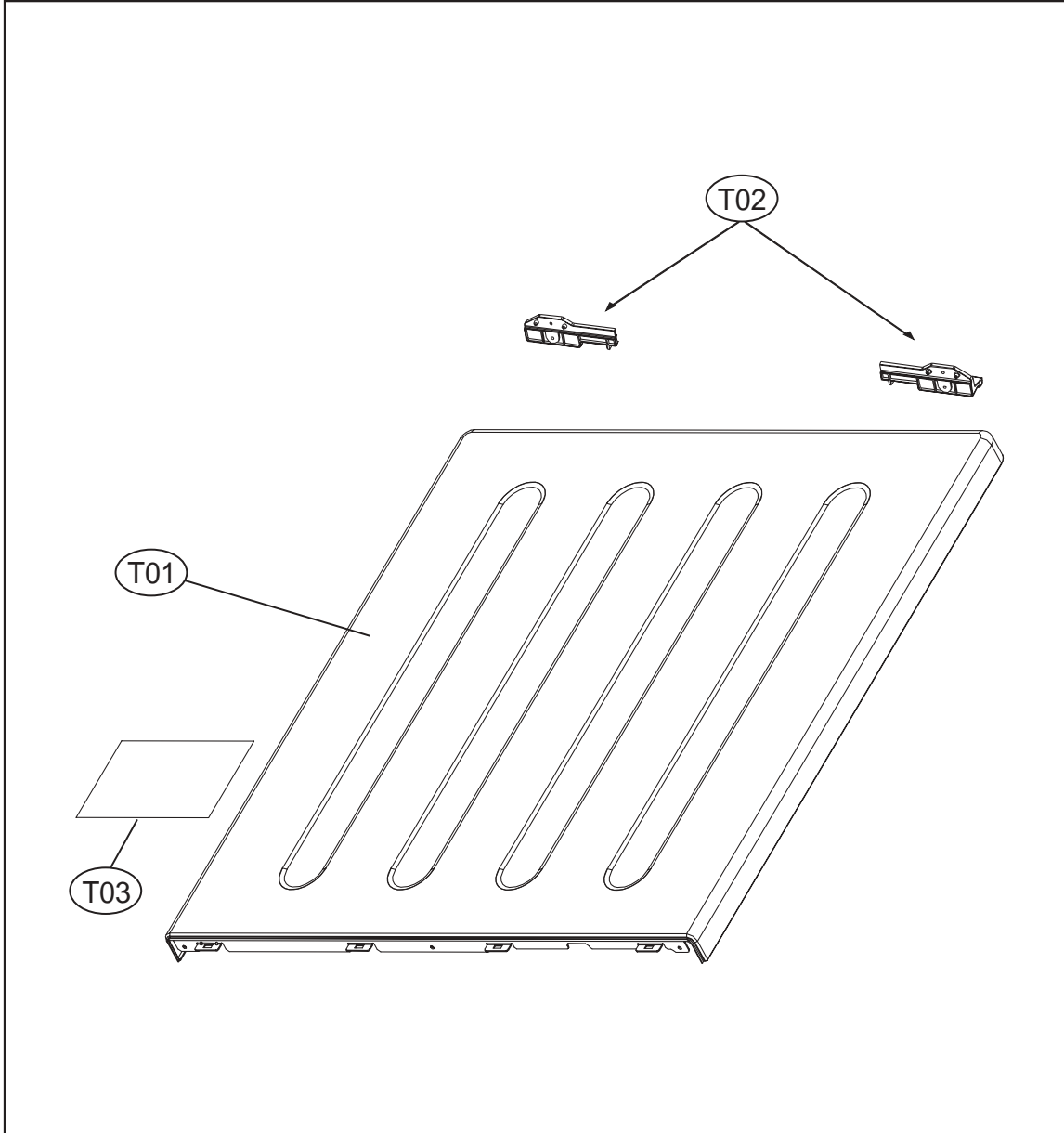

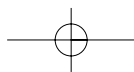

No.	Part Name	Part Code	Qty	Specification	Remark
T01	PLATE TOP AS	PRMACA3R00	1	SECD 1.2T + SPRAY	
T02	HANDLE REAR (PLATE SUPPOTER)	3615304100	2	ABS	
-	SCREW TAPPING	7122401411	4	T2S TRS 4x14 MFZN	

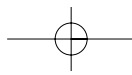

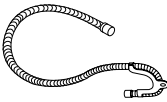
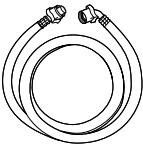
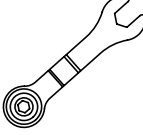
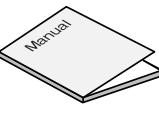

10. ACCESSORY

A01	A02	A03
		
A04	A05	A06
		

No.	Part Name	Part Code	Descriptions	Qt'y	Remarks
A01	HOSE DRAIN O AS	3613268500	DWD-800W, L=1,500	1	
	GUIDE DRAIN HOSE	3612502300	PP	1	
A02	HOSE INLET AS	3613271500	REFLEX, PVC 1.3M	1	Cold
	HOSE INLET AS	3613271510	REFLEX, PVC 1.3M	1	Hot
A03	UNIT SVC WRENCH	36189L3X00	PO+Coating, 2.3T DWD-110RP	1	
A04	MANUAL OWNERS	4589A61600	ASKO Manual	1	English & French
A05	CAP HOLDER	3610916400	PP, DWD-10RP	4	
A06	UNIT LEVELER AS	36189L4M00	FOOT 1 + LEG 1	1	Option
		36189L4M10	FOOT 1 + LEG 2	1	Option

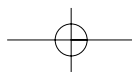

Control Part Function Spec

1. SEQUENCE CHART

Classification	Processing Time	Normal		Cotton		Delicate	Heavy duty	Sanitary		
		Small	Low	Small	Low			Small	Low	
Pre Wash	Sensing	10sec								
	Water Supply	2min								
	Pre-Wash	10min								
		8min								
	Drain	1min								
	Balancing Spin	2min								
Middle Spin	3min									
Wash	Sensing	20sec								
	Water Supply	2min								
	"Main-Wash 1 (Heating)"	50min							53min	72min
		45min						35min		
		30min	18min	22min	16min	17min				
		25min					8min			
15min										
Rinse	Drain	1min								
	Balancing Spin	2min								
	Middle Spin	3min								
	Water Supply	2min								
	Rinse 1	4min								
	Drain	1min								
	Balancing Spin	2min								
	Middle Spin	3min								
	Water Supply	2min								
	Rinse 2	4min								
	Drain	1min								
	Balancing Spin	2min								
	Middle Spin	3min								
	Water Supply	2min								
Rinse 3	4min									
Spin	Drain	1min								
	Balancing Spin	2min								
	Spin	9min								
		7min								
6min										
End	Clothes Release	60sec								
	End	10sec								
Remain Time Display			55	59	53	54	32	1:12	1:30	1:34
NOTE										

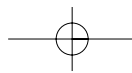

Classification		Processing Time	Perm Press WD1352	Steam fresh WD1352S	Speed Wash	Baby care	Gym shoes	Drum-c
Pre Wash	Sensing	10sec						
	Water Supply	2min						
	Pre-Wash	10min						
		8min						
	Drain	1min						
	Balancing Spin	2min						
	Middle Spin	3min						
Wash	Sensing	20sec						
	Water Supply	2min	■		■	■	■	■
	"Main-Wash 1 (Heating)"	50min						
		45min						
		30min						Soak 30min
		25min	22min			19min	19min	
15min		■		8min	■	■	13min	
Rinse	Drain	1min	■		■	■	■	■
	Balancing Spin	2min	■		■	■	■	■
	Middle Spin	3min	■		■	■	■	■
	Water Supply	2min	■		■	■	■	■
	Rinse 1	4min	■		■	■	3min	■
	Drain	1min	■		■	■	■	■
	Balancing Spin	2min	■		■	■	■	■
	Middle Spin	3min	■		■	■	■	■
	Water Supply	2min	■		■	■	■	■
	Rinse 2	4min	■		■	■	3min	■
Spin	Drain	1min	■		■	■	■	■
	Balancing Spin	2min	■		■	■	■	■
	Spin	9min	■		■	■	■	■
		7min	■		■	■	■	■
6min	■		■	■	5min	■		
End	Clothes Release	60sec	■		■	■	■	■
	End	10sec	■		■	■	■	■
Steam Pre-Heating				■ 30 s				
Steam				■ 5min				
Cooling				■ 10min				
Remain Time Display			59	16	33	1:20	45	1:20
NOTE								

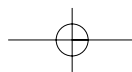

2. Composition per Function

2-1. Water Supply

1) Water Temperature Selection

Water supply algorithm differs according to water temperature selected among 5 levels.

In other temperatures, with the exception of cold water, constant temperature control is executed.

Cold water and hot water operation is carried out in turn according to the target temperature.

Water Temp.	Target Temp.	Target 1	Target 2
Extra Hot/Cold	67°C	67°C	70°C
Hot/Cold	35°C	39°C	36°C
Warm/Warm	30°C	29°C	31°C
Warm/Cold	30°C	29°C	31°C
Cold/Cold	-	-	-

2) For Cold/Cold, valve operation does not change according to temperature and only the time unit of cold on for 7sec and off for 9sec is set to supply cold water per each unit of 16sec.

① Pre-wash V/V Operation

On for 3sec/ off for 2sec - Twice: Removing residual detergent from water supply box

② During the initial water supply for washing water is received 5mm higher than the set level.

3) How to Insert Bleach

① During Washing

Operation for 12sec after 3-minute washing in wool, delicate and speed wash courses

Operation for 12sec after 5-minute washing in cotton course

Operation for 12sec after skipping soaking and 4-minute of washing in Drum-cleaning course

Operation for 12sec after soaking and 4- minute of washing in Drum-cleaning course

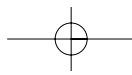

2-2. Drainage

1) Pump Operation - Washing cycle

- ① Before Drainage Completion: Pump continuously on
- ② Spin-drying Cycle after Drainage Completion
: On for 18sec and off for 3sec

2-3. Sensor Detection

1) Water Level Sensor

– Water Level Data

Classification Water Level	Height (mm)	Frequency (KHz)	Remarks
Spec. Small	130	24.62	
Spec. Low	130	24.62	
Washing Small	130	24.38	
Washing Low	130	24.09	
Standard Rinsing	160	24.27	
Rinsing	160	23.64	
Additional Rinsing	175	24.01	
Tub Washing	195	23.77	
Overflow	260	22.6	
Safety	125	24.7	
Reset	125	24.68	

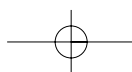

2) Washing Temperature Sensor

① Standard resistance of 4.7k Ω -49°C...

② Temperature Sensor Data

Temp.	Resistance(Ω)	Voltage	Remarks
0	35.97	0.58	
10	22.76	0.86	
20	14.77	1.21	
22	13.57	1.29	
24	12.48	1.37	
25	11.98	1.41	
27	11.04	1.49	
29	10.18	1.58	
30	9.78	1.62	
32	9.04	1.71	
34	8.36	1.80	
36	7.74	1.89	
38	7.17	1.98	
40	6.65	2.07	
49	4.7	2.50	
55	3.85	2.75	
60	3.24	2.96	
65	2.74	3.16	
75	1.99	3.51	

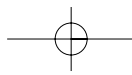

2-4. How to Control Voltage (During abnormal operation)

1) Voltage Control

① Normal Voltage

DC-link voltage after wave rectification is directly impressed to IPM as 310 ~ 330V.

When motor starts operation, DC voltage changes with energy consumed by motor and/ or counter electromotive force of motor.

② Identifying Abnormal Voltage

A. Occurrence of counter electromotive force

☞ In case of 450V or higher

B. Instant power failure and excessive energy consumption

☞ In case of 185V or lower

2-5. How to Control Current (During abnormal operation)

1) Current Abnormality Detection

① Abnormal if DC current flowing through IPM measured during high-speed motor rotation is 10A~12A or higher

② Detection of abnormal current to be carried out by saving higher value among instant current values and updating the data

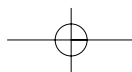

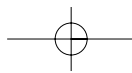

2-6. Door S/W

1) Door S/W Operation

① Door Locking

3sec after bi-metal operation of door S/W, pulse of 20msec duty on solenoid is impressed twice until door is locked. Bi-metal begins operation simultaneously as power button is pressed.

② Door Unlocking

Bi-metal plate of door S/W is turned off and pulse of 20msec duty on solenoid is impressed until door is unlocked.

③ Motor or other electronic parts begin operation to execute normal cycles only when door is locked.

④ Door is closed if temperature measured by washing temperature sensor after turning on power button is 55°C or higher or if water level is higher than safety level.

⑤ Door is opened immediately when cycle is finished.

⑥ During cycle suspension, door is opened anytime if allowable by conditions.

2) Door Open System

① To forcefully open door in order to additionally insert the laundry during washing, door can be opened by pressing unlock clear button.

② Door open system by unlock clear button is to forcefully open door when not in conditions for door opening. It begins the sequence to satisfy conditions for door opening.

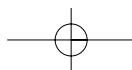

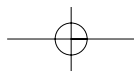

2-7. Load Sensing

1) Load Sensing to Determine Water Level

- ① Load sensing is carried out when selecting Normal. Cotton, Sanitary course.
- ② Sensing is administered in the dry laundry state before starting of washing cycle.
- ③ After motor operation at 75 r.p.m for 10sec, load is judged with motor output measured.

2) Load Sensing for B Spin-drying

- ① Sensing is administered with the laundry wet during the first interim spin-drying after completion of washing cycle.
- ② After motor operation at 75 r.p.m for 10sec, load is judged with motor output measured.
- ③ Base values for B spin-drying unbalance of interim and main spin-drying are selected according to load measured by sensing.

2-8. Child Lock

- ① Child lock mode begins by pressing 'Beeper' button during cycle.
- ② In child lock mode, all buttons, with the exception of power button, are not operated.
- ③ In child lock mode, cycle display window is lit to show that child lock has been applied. Also, the remaining time is displayed in '18:88' window.
- ④ Lock mode is cleared by pressing 'Beeper' button as was done when starting child lock mode.

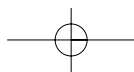

3. Functions per Cycle

3-1. Washing Cycle

1) Classification of Washing

- ① Pre-washing and soaking are carried out before main washing cycle.
- ② Decided value refers to water level and time decided by load sensing in standard, boiling and thrifty boiling courses. In other sources, it means the pre-set time according to the designated water level.
- ③ Soaking is the cycle consisted with water supply and washing only. Main washing begins immediately after this cycle without drainage.
- ④ In pre-washing and soaking cycles, only cold water is used and heating is not administered.

2) Heater Operation

- ① Washing heater does not re-operate once turned off after reaching the set temperature.
- ② Even when target water temperature is not reached, washing cycle is finished when washing time expires.

3) Re-supply of water

- ① Re-supply is carried out in case water level detected per 2 minute after water supply completion is lower than the set water level.
- ② Motor is stopped during re-supply.
- ③ During washing, re-supply is carried out up to 10 times. After the 10th time, re-supply is not administered even if water level drops.
- ④ Re-supply is not carried out if more than half of washing time has passed and heater is turned off.

3-2. Rinsing Cycle

1) Water Supply Cycle

- ① When selecting 'add water for rinsing', water is supplied to the water level of additional rinsing.
- ② Only cold water is supplied in rinsing cycle.
- ③ In the last rinsing, fabric softener is inserted by opening both cold water V/V and pre-washing V/V at the same time.

2) Re-supply of Water

- ① Water level is checked 1 minute after starting of rinsing cycle. Then, water is re-supplied up to the designated water level.

3) Drainage

- ① To administer drainage after completing washing at water temperature of 55°C or higher, drainage is carried out after dropping water temperature by supplying cold water to high level.
- ② When drainage cycle begins, drainage motor is continuously kept on.

4) Interim Spin-drying

- ① Interim spin-drying is administered up to the r.p.m designated per each course.
The following cycle begins if R spin-drying is not reached after 20 times of balance spin-drying.
- ② After completion of washing cycle, load sensing is carried out before the first interim spin-drying to detect load. Then, the cycle proceeds to main spin-drying by differing standard unbalance values according to the load.

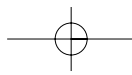

3-3. Spin-drying Cycle

1) Drainage

- ① Drainage set time is 1min.
- ② When drainage is completed, 1 minute is reduced from the overall cycle.

2) Balance Spin

Motor running during balance spin

- ① Spreading the laundry : Rotating the same 45rpm with left and right direction alternatively.
- ② Attaching stop : Attaching the laundry to drum inside with constant speed.
- ③ Unbalance checking point : First step, check the U.B at 95 rpm, 160rpm
 Second step, check the U.B at 95 rpm, 350rpm
 Third step, at 300rpm. if the unbalance data is over the criterion
 This process will be repeated
- ④ Drain step : Drain at water around 160rpm
- ⑤ After drain, check the unbalance data again. This is so-called balance spin step.

3) R (Real) Spin-drying

- ① 'R spin-drying' refers to the process until completion of spin-drying after B spin-drying.
- ② The r.p.m reached differs according to the spin-drying cycle selected.
- ③ When acceleration ends during spin-drying, constant-speed operation is carried out at the r.p.m set in the selected cycle. Breaking is carried out after deceleration to app. 450 r.p.m.
- ④ When stopping cycle by pressing temporary stop button during spin-drying, breaking is carried out to stop motor.
- ⑤ Max. r.p.m operation time according to spin-drying selection

(rpm)

Spin Level	MAX(1200)	MAX(1300)	Remark
NO SPIN	0	0	
Low	550	550	
Medium	850	850	
High	1100	1100	
Extra High	1200	1300	

4) No Drainage

- ① Cycle is completed without drainage after rinsing is finished

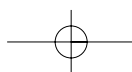

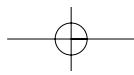

3-4. Ending

1) Untwisting

- ① This cycle aims to prevent creasing by loosening the laundry attached to the inner wall of drum after completion of spin-drying. Untwisting is carried out for 30sec.
- ② Motor is operated according to the water stream of untwisting.

2) Ending

- ① After completion of untwisting, buzzer is sounded for 10sec and power is turned off.
- ② In case additional drying cycle has been set, drying cycle is carried out after untwisting.
- ③ After ending process begins, door lock is cleared.

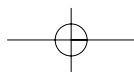
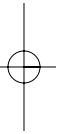
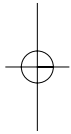

4. Button Functions

4-1. Power

- 1) This electronic power switch turns on/ off display.
- 2) Automatic Power Switch Off
 - ① Power is turned off immediately after completion of entire cycles or the selected cycle.
 - ② Power is automatically turned off in 10 minutes if no button control is made after power on.
- 3) Initial Display for Power Only
 - ① All course LED is turned on
 - ② 18:88 LED displays '---'.

4-2. Start/Pause

- 1) Normal course begins when pressing button after turning on power S/W.
- 2) Operation begins by pressing button after setting a program course or automatic course of 11 varieties.
- 3) If button is pressed during operation, blinking of cycle lamp changes to lighting only and operation stops. When button is pressed again, operation restarts from the point of temporary suspension.
- 4) If cycle is changed by controlling button or encoder switch in temporary suspension state, the mode is changed to the initial mode.
- 5) Lock is cleared if in the corresponding conditions by judging values of washing temperature sensor or water level during temporary suspension.

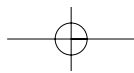

4-3. Wash/Rinse

- 1) Range of temp. selection differs according to the course selected. (Refer to washing functions per cycle.)
- 2) The front part of text displayed indicates water temperature for washing and the back part indicates water temperature for rinsing.
ex) Warm / Cold
 Warm : Water temperature for washing
 Cold : Water temperature for rinsing
- 3) Cold water and hot water supply method differs according to water temperature selection. Heating temperature also differs.
- 4) For sanitary course, water temperature is fixed at 'Extra Hot/Cold'. When pressing water temperature button during temporary suspension, buzzer is sounded and water temperature selection is not made.
- 5) Even in sanitary course, water temperature selection can be made during rinse spin from 'Warm/Warm' to 'Cold/Cold'.

4-4. Spin Speed

- 1) When pressing button, LED is repetitively lit in the order of " Medium → High → Extra High → No Spin → Low'.
- 2) If drying cycle is selected, operation is carried out as extra high regardless of spin selection.
- 3) 18:88 display shows the remaining time.
- 4) During cycle, selection change is possible after temporary suspension.

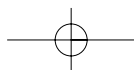

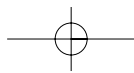

4-5. Soil Level

- 1) When pressing button, LED is repetitively lit in the order of " Normal → ▼ → High → Off → Light → ▼"
- 2) Soil level can be selected only when washing cycle is set.
- 3) Soil level is operated in courses other than 'Drum Cleaning', 'Wool' and 'Speed Wash'.
- 4) Washing time changes according to the selected soil level.
ex) In case of normal course, water temp. of Warm/Warm and water level of 'low' In the order of Soil Level 'Light - ▼ - Normal - ▼ - High', washing time changes in the order of '18min - 23min - 28min - 31min - 33min'.
- 5) Selection can be changed during cycle after temporary suspension.
- 6) Overall cycle time is shown in 18:88 display.

4-6. Beeper

- 1) Beeper button operates in 5 steps.
Changing in the order of 'HIGH--> ▼ --> Low --> ▼ --> Beeper Off'.
- 2) After change, it is saved in EEPROM.

4-7. Delay Wash

- 1) Preset time indicates ending time of the entire cycle.
- 2) When pressing preset button, time changes in the order of 2→ 3→ 4→ ... → 12→ 2.
- 3) After selecting preset time, cycle change is possible before entering preset mode by pressing start/ temporary stop button.
However, cycle cannot be changed after entering preset mode.

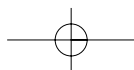

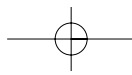

-
- 4) To preset operation, select cycle → select preset time → press start/ temporary stop button.
 - 5) The selected cycle is displayed for 3 seconds when pressing start/ temporary stop button after entering preset mode to check the selected cycle.
 - 6) Preset is not possible in wool, delicate and drum cleaning courses.

4-8. Pre-Wash

- 1) Button is operated only when washing is selected.
- 2) Pre-wash is not available in wool, speed wash and drum cleaning courses.
- 3) When pressing button, pre-wash is added and LED is lit. LED is turned off when pressing the button again.
- 4) Pre-wash LED is turned off when pre-wash is completed.

4-9. Steam

- 1) Button is operated only when washing is selected.
- 2) Steam is not available at any courses as '4-16 Option Button'.
- 3) When pressing button, steam is added and LED is lit. LED is turned off when pressing the button.
- 4) Steam LED is turned off when washing is completed.

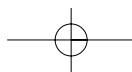

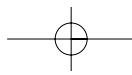

4-10. Rinse+Spin

- 1) Rinse + spin is not available in drum cleaning course.
- 2) When pressing button, rinsing once + spin medium is selected.
- 3) Operation does not return to previous cycle even when pressing the button again. The cycle set in the corresponding course is displayed by rotating course dial. Then, rinse spin LED is turned off.
- 4) Water temperature can be selected with Temp. button after rinse + spin is set.
Selection can be made from Cold/Cold to Warm/Warm.
- 5) Even after rinse + spin is selected, water temperature selection cannot be made in wool and drum cleaning courses.
- 6) When cycle is completed, LED is turned off.

4-11. Extra Rinse

- 1) Extra rinse is not available in speed wash and drum cleaning courses.
- 2) When pressing button rinsing cycle is added by once and LED is lit. When pressing button again, rinsing cycle decreases by once and LED is turned off.
- 3) Extra rinse LED is turned off when rinsing is completed.

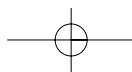

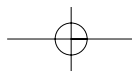

4-12. Extra Wash

- 1) When pressing button, washing time increases by 8min in heavy duty and sanitary courses.
- 2) When pressing button, washing time increases by 5min in normal and cotton courses.
- 3) Extra wash is not available in wool, drum cleaning, delicate and speed wash courses.
- 4) Extra wash LED is turned off when washing is completed.

4-13. Night Time

- 1) When pressing button, spin speed is set as low and interim spin-drying changes from 790r.p.m to 550r.p.m.
- 2) When pressing button again, set values of interim spin-drying and main spin-drying mode courses are resumed.
- 3) LED is turned off when the cycle is completed.

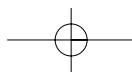

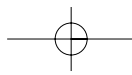

4-14. Custom Program

1) When pressing custom button for the first time, the memorized program is loaded and shown in display window.

To identify whether it is a memorized program and if custom button has been pressed, 'CEP' and cycle time are displayed in turn in '18:88' display window.

Overall time is displayed only when cycle begins with start button.

2) When custom program is temporarily stopped and custom button is pressed again, basic cycle of normal course is set. Water level and load are set as well.

'18:88' display window shows the overall time.

3) Set values are saved when pressing start button in custom mode.

3) Set values are saved when pressing start button in custom mode.

4) Custom setting is administered in the following order.

- Power on --> custom button on --> course and cycle selection --> start button on ==> saved

4-15. Course Selection Switch

1) Normal course selected by clicking switch once after power is turned on.

2) Per each click after the first, course is selected in the direction of CW or CCW.

3) 18:88 display indicates cycle time of each course.

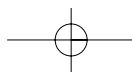

4-16. Option Button

	Default Temp Spin Soil	Temp	Spin	Soil	Beeper	Delay Wash	PreWash /Steam	Extra Wash	Extra Rinse	Rinse +Spin	Night Time	Custom Program
Baby care	warm/warm Medium Normal	Cold/Cold- ExHot/Cold	NoSpin ~ ExtraHigh	Light- Heavy	Off~ High	O	O	O	O	O	O	O
Delicate	cold/cold low Normal	Cold/Cold	NoSpin ~ Medium	Light- Heavy	Off~ High		O/x		O	O	O	O
Permpress (non-steam)	warm/cold low Normal	Cold/Cold- Hot/Cold	NoSpin ~ ExtraHigh	Light- Heavy	Off~ High	O	O	O	O	O	O	O
Steam fresh (steam)	- - -	-	-	-	Off~ High	-	-	-	-	-	-	O
Cotton	warm/cold ex high Normal	Cold/Cold- Hot/Cold	NoSpin ~ ExtraHigh	Light- Heavy	Off~ High	O	O	O	O	O	O	O
Normal	warm/cold Medium Normal	Cold/Cold- Hot/Cold	NoSpin ~ ExtraHigh	Light- Heavy	Off~ High	O	O	O	O	O	O	O
Heavy Duty	warm/cold Medium Normal+	Cold/Cold- Hot/Cold	NoSpin ~ ExtraHigh	Light- Heavy	Off~ High	O	O	O	O	O	O	O
Gym shoes	warm/cold low Normal	Cold/Cold- Warm/Cold	NoSpin ~ Medium	Light- Heavy	Off~ High		O	O	O	O	O	O
Sanitary	Exhot/cold Medium Normal	ExHot/C	NoSpin ~ ExtraHigh	Light- Heavy	Off~ High	O	O	O	O	O	O	O
Speedwash	cold/cold low light	Cold/Cold- Warm/Cold	NoSpin ~ Medium	Light	Off~ High	O				O	O	O
Drum Cleaning	cold/cold low light	Cold/Cold	Low	Light	Off~ High						O	O

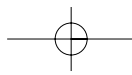

5. MANUAL TEST MODE

- PCB and other electronic parts will be tested without water supply whether they are normal or not.

1) Process

: Press power button -> Press "SPIN" button 3 times with pressing "WASH" button -> "X X X" will be shown on LED display-> Whenever pressing "Beeper" button 1 time, below process will be occurred.

- "X X X" : Program version display

Step	Display		Details
1	L_C		Door Lock Close
2	run	001	Running times count
3	b1	0	HALL-SENSOR ERROR count
4	b2	0	IPM-FAULT ERROR count
5	b3	0	Over-load ERROR count
6	b4	0	Motor align ERROR count
7	b5	0	Rpm checking ERROR count
8	b6	0	Overvoltage ERROR count
9	b7	0	Low voltage ERROR count
10	L		No use
11	H		Hot Valve
12	C		Cold Valve
13	P		Pre Wash Valve
14	U		No use
15	bb		Bleach Valve
16	dr		Drain Pump
17	L_O		Lock Open

2) More details

- When turn on 'LOCK' signal, all process is conducting normally.
- In this case, BLDC Motor is not tested. In order to test it, select spin or rinse.

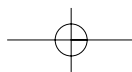

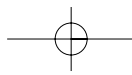

6. Abnormality Notification

6-1. IE (Input Error) - Error in water supply

1) Conditions of Occurrence

- ① In case the designated water level is not reached in 5 minutes during water supply or re-supply

2) All LEDs are turned off and 'IE' blinks in 18:88 display.

3) Error buzzer alarm is sounded for 10 seconds per every 10 minutes.

4) Error display is cleared when turning off/ on power.

6-2. OE (Output Error) - Error in drainage

1) Conditions of Occurrence

- ① In case water level does not reach reset point in 10 minutes after drainage starts

2) All LEDs are turned off and 'OE' blinks in 18:88 display.

3) Error buzzer alarm is sounded for 10 seconds per every 10 minutes.

4) Error display is cleared when turning off/ on power.

6-3. UE (Unbalance Error)

1) Conditions of Occurrence

- ① In case main spin-drying is not reached within 20 cycles of balance spin-drying
- ② In case balance spin-drying fails during interim spin-drying, UE occurs as the cycle moves to the next process.

2) All LEDs are turned off and 'UE' blinks in 18:88 display.

3) Error buzzer alarm is sounded for 10 seconds per every 10 minutes.

4) Error mode is cleared by opening door and organizing the laundry in spin-dry chamber, closing door and pressing start/ temporary stop button. Then, spin-drying begins again.

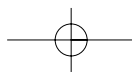

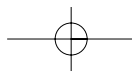

6-4. LE (Lock Error) - Door opening error

1) Conditions of Occurrence

- ① When intending to begin cycle by pressing start/ temporary stop button while door is opened

2) All LEDs are turned off and 'LE' blinks in 18:88 display.

3) Error buzzer alarm is sounded for 10 seconds per every 10 minutes.

4) Error display is cleared when turning off/ on power.

6-5. E1 - Water level detection error

1) Conditions of Occurrence

- ① In case water level is below reset or overflow is detected in line test mode

2) Water supply motor is kept on until water level falls below reset.

3) All LEDs are turned off and 'E1' blinks in 18:88 display.

4) Error buzzer alarm is sounded for 10 seconds per every 10 minutes.

5) Error display is cleared when turning off/ on power.

6-6. E2 - Overflow error

1) Conditions of Occurrence

- ① In case water level in water tank is above overflow level due to continuous operation of water supply valve

2) Water supply motor is kept on until water level falls below reset.

3) All LEDs are turned off and 'E2' blinks in 18:88 display.

4) Error buzzer alarm is sounded for 10 seconds per every 10 minutes.

5) Error display is cleared when turning off/ on power.

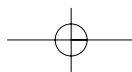

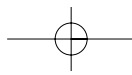

6-7. E4 - Water leakage during washing

1) Conditions of Occurrence

- ① In case water level falls below re-supply even after 15 times of re-supply prior to finishing of water heating

2) All LEDs are turned off and 'E4' blinks in 18:88 display.

3) Error buzzer alarm is sounded for 10 seconds per every 10 minutes.

4) Error display is cleared when turning off/ on power.

6-8. E9 - Abnormalities in water level sensor

1) Conditions of Occurrence

- ① In case water level frequency is of 15KHz or lower and 30KHz or higher during cycle due to abnormalities in water level sensor, etc.

2) All LEDs are turned off and 'E9' blinks in 18:88 display.

3) Error buzzer alarm is sounded for 10 seconds per every 10 minutes.

4) Error display is cleared when turning off/ on power.

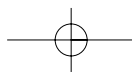

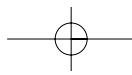

6-9. Motor-related Error

1) E5 (DC-Link High Voltage) Error

- ① In case DC-link voltage to IPM increases to 450V or higher
- ② Motor operation is stopped and 'E5' is shown in display window.
- ③ Error buzzer alarm is sounded for 10 seconds per every 10 minutes.
- ④ Error display is cleared when turning off/ on power.

2) E6 (EMG) Error

- ① In case current detected with EMG port is of 20A or higher
- ② Motor operation is stopped and 'E6' is shown in display window.
- ③ Error buzzer alarm is sounded for 10 seconds per every 10 minutes.
- ④ Error display is cleared when turning off/ on power.

3) E7 (Direction) Error

- ① In case signal of Hall IC is different from the predicted signal according to direction of rotation
- ② Motor operation is stopped and 'E7' is shown in display window.
- ③ Error buzzer alarm is sounded for 10 seconds per every 10 minutes.
- ④ Error display is cleared when turning off/ on power.

4) E8 (Initial Operation Fail) Error

- ① In case input signal of Hall IC is abnormal due to problems in motor connection, etc.
- ② Motor operation is stopped and 'E8' is shown in display window.
- ③ Error buzzer alarm is sounded for 10 seconds per every 10 minutes.
- ④ Error display is cleared when turning off/ on power.

6-10. Error in Temperature Sensor

1) H2 Error - Washing temperature sensor open/ short

- ① In case washing temperature sensor is defective or not connected
- ② Error buzzer alarm is sounded for 10 seconds per every 10 minutes.
- ③ Error display is cleared when turning off/ on power.

2) H4 Error - Washing temperature sensor overheating

- ① In case temperature detected by washing temperature sensor is 95 °C or higher
- ② Error buzzer alarm is sounded for 10 seconds per every 10 minutes.
- ③ Error display is cleared when turning off/ on power.

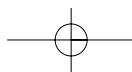

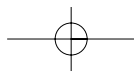

3) H5 Error - Water temperature error in wool/ delicate course

- ① In case water temperature in wool/ delicate course is 45°C or higher
- ② Error buzzer alarm is sounded for 10 seconds per every 10 minutes.
- ③ Error display is cleared when turning off/ on power.

4) H6 Error - Abnormality in washing heater

- ① Within 15 minutes after heater operation begins;
In case standard temperature is of 42°C or lower: If temperature does not increase by 2°C or more In case standard temperature is higher than 42°C: If temperature does not increase by 1°C or more
- ② If temperature falls below standard temperature by 2°C or more due to re-supply of water, etc., standard temperature is reset as the current temperature and error check time of 15 minutes is reset.
- ③ Error buzzer alarm is sounded for 10 seconds per every 10 minutes.
- ④ Error display is cleared when turning off/ on power.

5) H8 Error - Washing heater overheating

- ① In case washing heater temperature increases by 5°C or more within 30 seconds when there is no water in tank, etc.
- ② Error buzzer alarm is sounded for 10 seconds per every 10 minutes.
- ③ Error display is cleared when turning off/ on power.

6-11. PFE (Pump Filter Error)

- ① Cycle is skipped to the next when the current r.p.m. is different from the target r.p.m by 70 during interim spin-drying.
- ② Cycle is skilled to balance spin-drying when the current r.p.m is different from the target r.p.m by 70 during main spin-drying.
- ③ 'PFE' error is caused if main spin-drying skip of ② above occurs 10 times.
- ④ Error display is cleared when turning off/ on power.

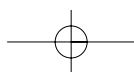

PCB PIN ARRANGEMENT

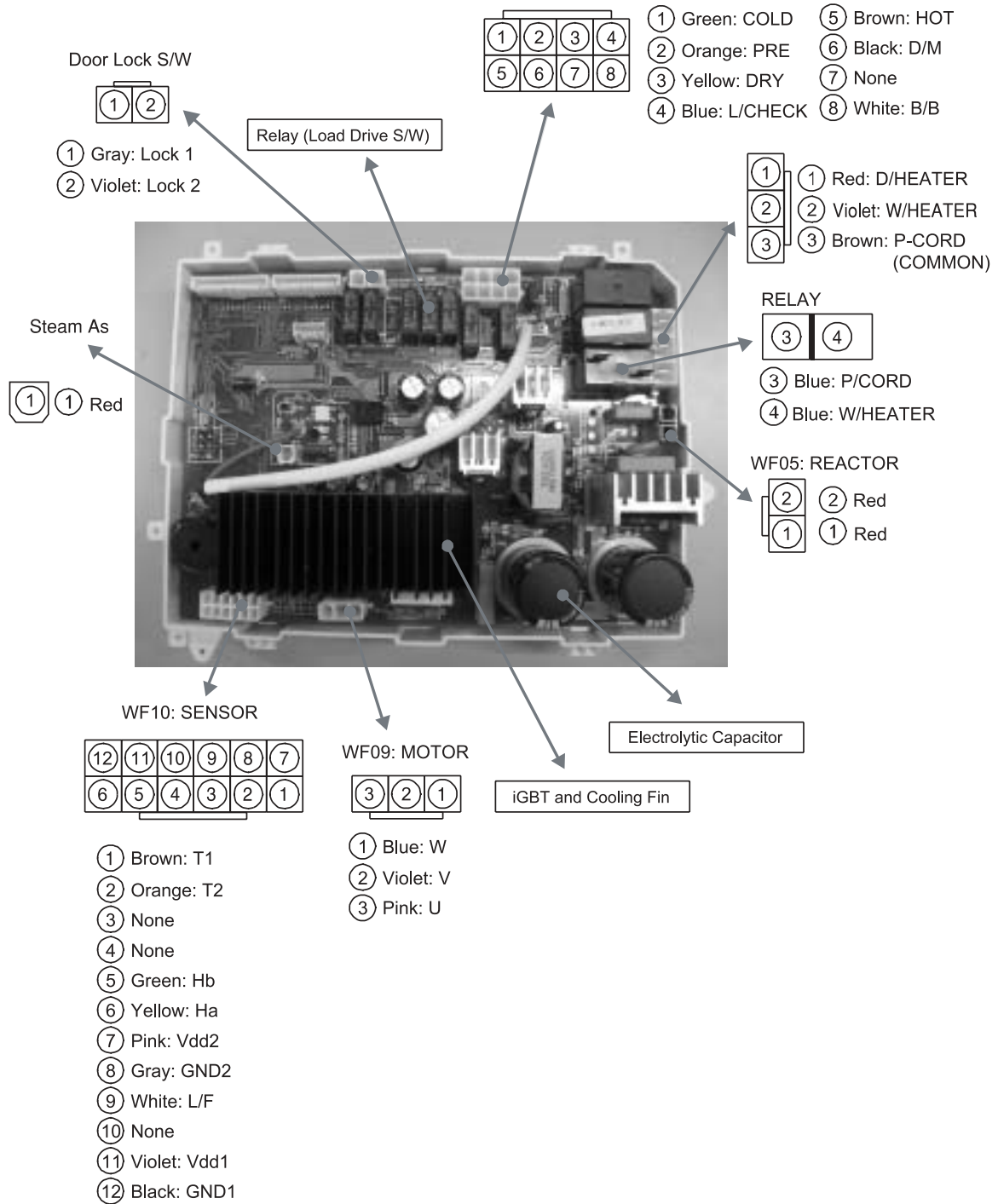

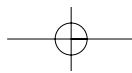

■ Electronic Parts List Spec.

1. VALVE INLET

Classification	3-way, 4-way Valve and Hot Water Valve					
Code	3-hole: 3615416930, 4-hole: 3615417601, Hot Water: 3615416700					
Color	Gray					
Coil Resistance	4320 ~ 5280 Ω					
Use	Supplying water for washing/ pre-washing, bleach and Steam					
Appearance Structure						
Symptoms of Breakdown	Detailed Symptoms	Cause	Diagnosis of Defect	Solution	PCB Error Mode	
Water not supplied	Water supply not carried, only noise is heard	Water tap not opened	Check for tap opening.	Open water tap.	"IE"	
		Coil short	Check if resistance between water supply valve terminals is within 4320-5280Ω.		"IE"	
		Excessive foreign substances in SUS filter	Remove water supply hose and check for foreign substances in filter.	Clean out foreign substances from inside the filter.	"IE"	
	Water supply not carried out without noise	Foreign substances in valve	-		Replace water supply valve.	"IE"
		Connector loosened	Visually check connector connection status.		Administer re-insertion.	"IE"
		Coil short	Check if resistance between water supply valve terminals is within 4320-5280Ω.		Replace water supply valve.	"IE"
Water is continuously supplied (inside tub)	Continuous water supply in power 'on' state	Wiring short	Wiring short --> Conduction test		"IE"	
		Defect in water level sensor	Refer to water level sensor defect check method.	Replace water level sensor.	"E2"	
	Defect in pressure hose	Check for blocking of holes in pressure hose.	Replace defect parts.	"E2"		
Others	Water leakage through sides	Defect in water supply valve	-	Replace water supply valve.	-	
		Defect in water supply valve assembly, etc.	Check for leakage through the sides of water supply valve.	Replace water supply valve.	-	

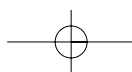

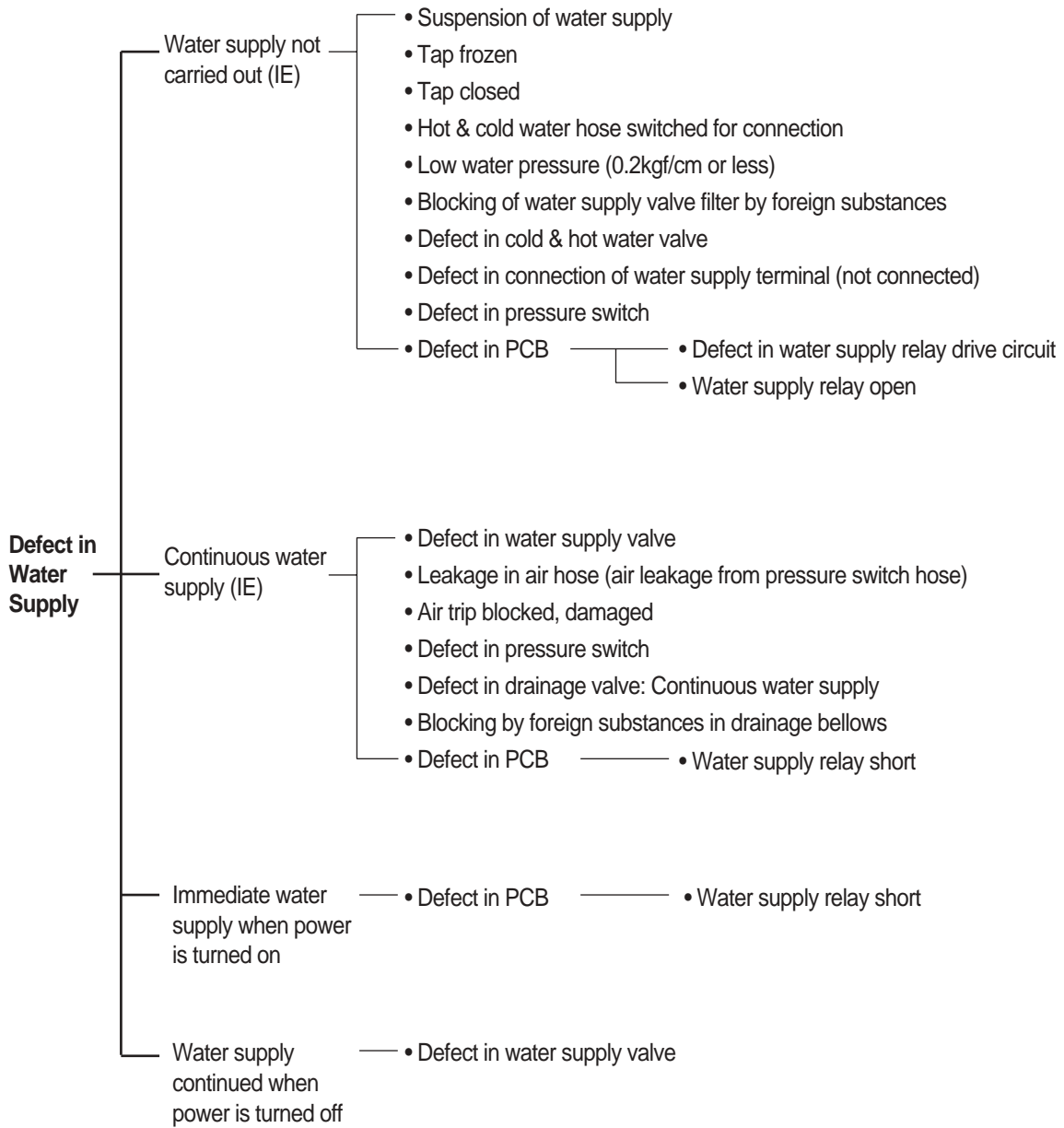

Symptoms of Breakdown	Inspection Spot	Inspection Method	Inspection Result	Problem Identified	Repair Method
Water supply not carried out		1) Suspension of water supply 2) Water tap locked 3) Cold-hot water hose incorrectly connected 4) If no defect is found, dismantle water supply hose and check water supply valve filter.	- Cold/ hot water hose switched -Large amount of rust, sand and dust, etc.	-Defect in cold/ hot water hose assembly -Defect in cleaning of water supply filter (blocked)	-Assemble cold/ hot water hose correctly. -Clean water supply filter.
	Water supply valve	1) Measure coil resistance in water supply valve. 2) Remove top cover and visually check for separation of water supply valve terminal connector and wiring short/ connection status. 3) In case water valve operation sound is heard, but water supply is not carried out, check for blocking of water supply valve or restraint on plunger.	-5.3kW or higher -Connector loosened/ not inserted -Electric wire short -Sound and defect in water supply due to foreign substances in bellows	-Coil short -Connection defect -Electric wire short -Structural defect in water supply valve	-Replace water supply valve. -Try reconnection or remove elements of connection defect. -Try reconnection or remove elements of connection defect. -Replace water supply valve.
	Pressure Switch	1) Check for 'E9' in display window.	-E9	-Loosening of pressure S/W terminal or electric wire short -Defect in pressure S/W	-Connect terminal of pressure S/W. -Connect terminal of PCB. -Replace pressure S/W.
Water supply not carried out	PCB	1. Check PCB pin connector insertion status. 2. Power is supplied to water supply valve terminal, but water supply is not administered.	Electric wire easily loosened when tugged PCB water supply circuit open, damaged (water supply relay operation not carried out)	Pin connector housing not inserted Defect in water supply circuit	Completely insert connector housing. Replace PCB.
Continuous water supply	PCB	1. Immediate supply when power is turned on	PCB water supply circuit or relay short (continuous conduction to valve)	Water supply relay short	Replace PCB.
	Water supply valve	1. Check if water supply is continuously carried out even if power is not on.	Water supply bellows blocked/ deformed	Defect in water supply valve	Replace water supply valve.
	Drainage drive motor (valve housing)	1. Check for normal operation of water supply valve/ water supply status. 2. Check if water is drained through drainage hose. 3. Check for foreign substances inside valve housing. 4. Check for foreign substances in drive motor wire. 5. Forcefully restore SUS wire.	-Not closed due to foreign substances inside drainage housing -Wire caught by foreign substances outside drive motor -Forced restoration not possible	-Foreign substances in valve housing -Foreign substances -Defect in drive motor restoration	-Remove foreign substances. -Remove foreign substance. -Replace drive motor.

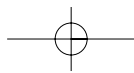

2. Water Level Sensor

1) Spec. of Water Level Sensor

<p>O/F: Forced drainage is necessary as water level is high. When this level is reached, water supply must be stopped and drainage must be forcefully administered.</p>	<p>RESET :</p> <ol style="list-style-type: none"> 1. Spin-drying begins 30sec after drainage level reset is reached. 2. Heater operation level 	<p>Low: Small load of laundry, therefore considered to be water level of 'low'</p> <p>Medium: Large load of laundry</p> <p>Medium High: Water level for rinsing</p> <p>Safety: Door open possible Door opened only when water level is below safety level</p>
---	--	---

Model	Code	Classification	O/F	Medium High	Medium	Low	Safety	Reset	Initial(Defect)	Inlet Angle
WD1132	3614825220	Frequency	22.60kHz	23.10kHz	23.20kHz	24.00kHz	24.40kHz	24.70kHz	25.80kHz	90°
	DN-DD03, DL-DW03	Water level (mm)	260±15	225±15	220±7	170±15	140±15	120±20	0	

2) Breakdown Analysis

Symptoms	Detailed Symptoms	Cause	Diagnosis	Solution	PCB Error Mode
Continuous water supply	Water valve normal	Defect in pressure sensor hose	Check for holes.	Replace hose.	"E2"
		Blocking of pressure sensor hose	Visual checking	Remove foreign substances.	"E2"
"E9"	Occurrence in water level sensor 30kHz or higher	Connector loosened	Visually check connector connection status.	Administer re-insertion.	"E9"
		Wiring short	Wiring short -> conduction test		"E9"

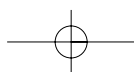

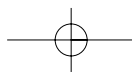
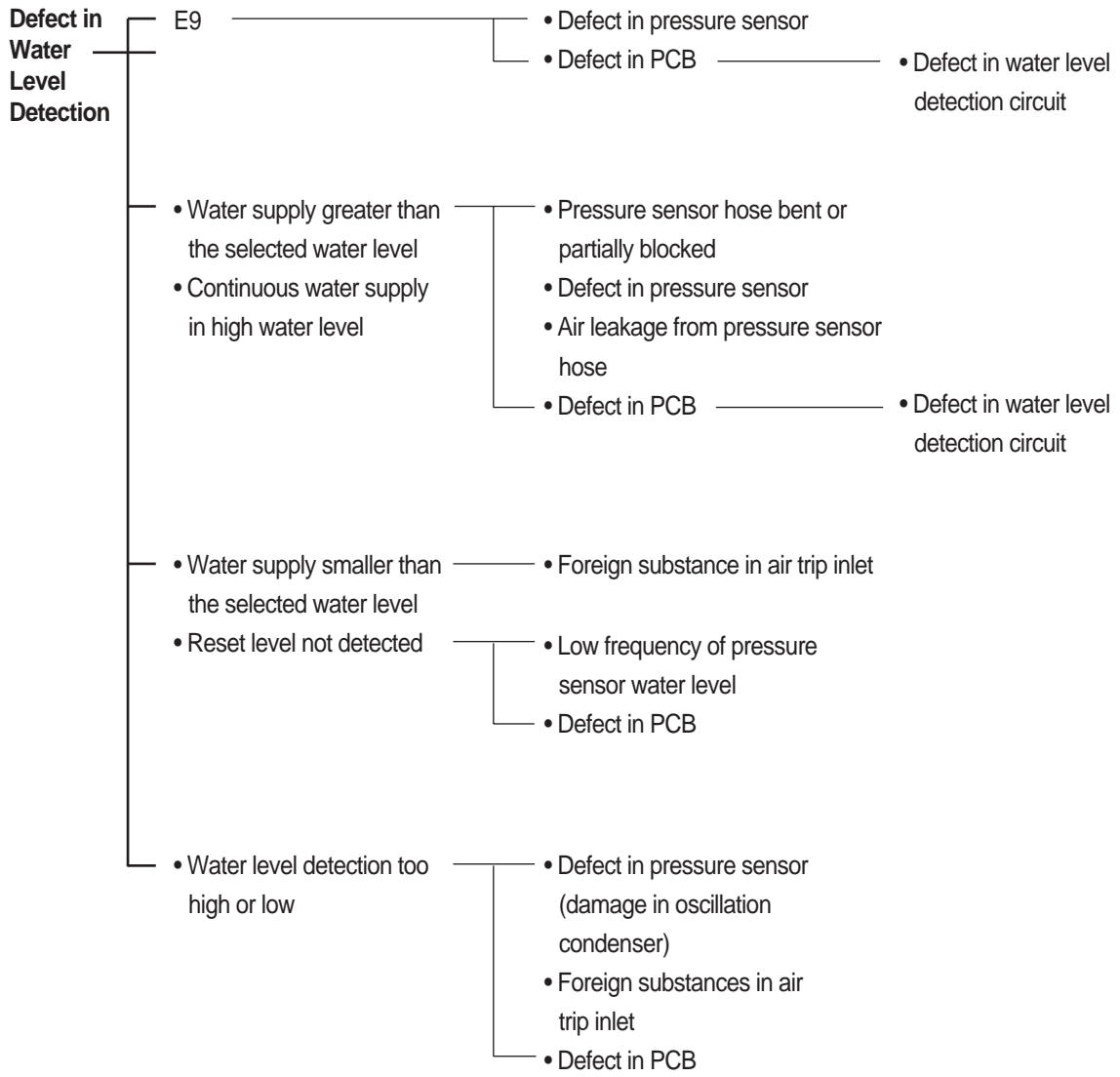
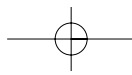

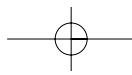

3. POWER CORD

Classification	Rated	Cord Thickness	Color	Code	Type	Length	Remarks
DEC	250V/15A	1.5sq	Gray	3611340430	LP-31 SJT	2.3m	-

1) Assembly

- . 4 embossed parts in cabinet
- > To prevent loosening after assembly

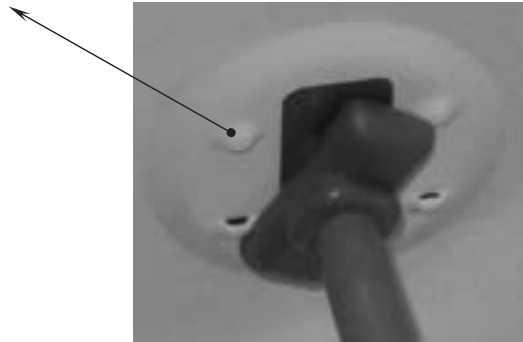

[Before]



[After]

. CONNECTOR

- > #1806 Housing 3P Used: Using both ends only and not the hole in the middle (materials highly resistant to flame)
- > To prevent fire caused by high current

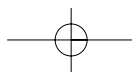

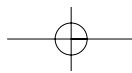

4. DOOR LOCK S/W

1) Comparison of Door Lock S/W Spec.

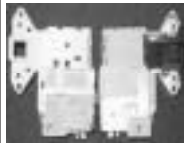
TYPE	CODE	MODEL	RATED	LOCK ON PRINCIPLE	LOCK 'ON'/OFF' TIME	LOCK OFF TYPE	EXTERNAL APPEARANCE
DF F01 007	3619046410	WD1132	125V 16A	Bimetal operation by PTC heating	-ON : Min. of 6sec -OFF after Cooling in Air: 40sec ~ 5min -Forced OFF: Immediate OFF (door opening) bimetal	1. Forced OFF by solenoid 2. Natural OFF by cool down of	

2) Structure and Spec. of Door Lock S/W: DF SERIES

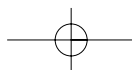
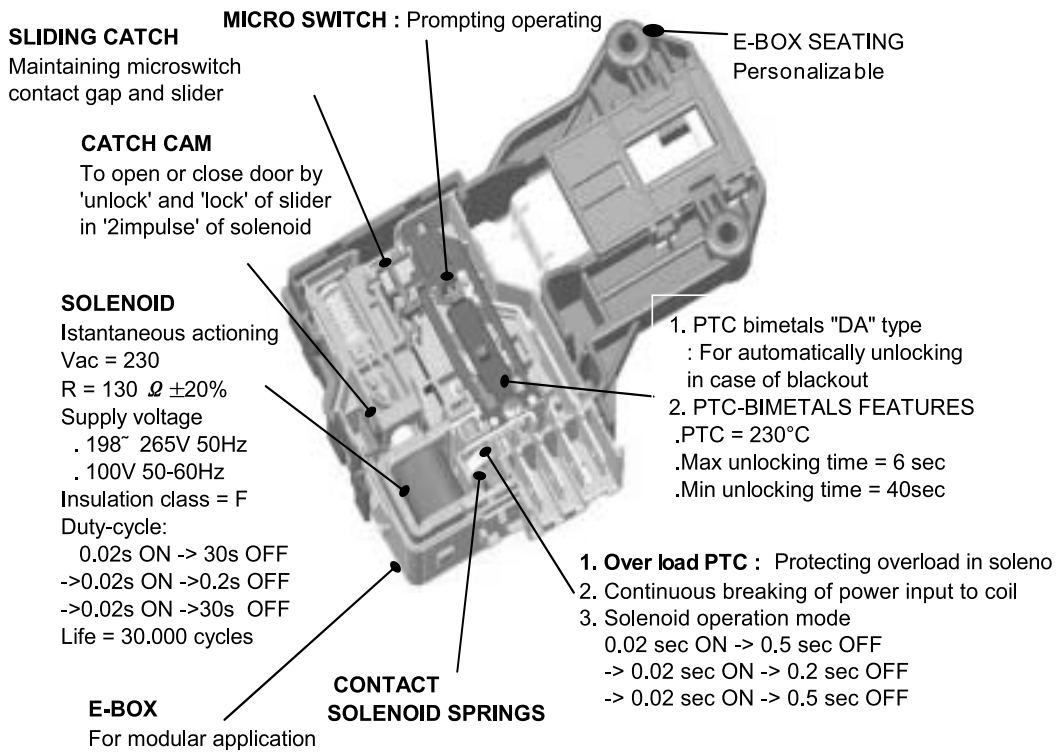

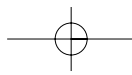

*** How to Replace Door Lock Switch**

- 1) Open door and dismantle clamp spring for gasket.
- 2) Dismantle gasket.
- 3) Loosen 2 screws for door lock S/W.
- 4) Remove door lock S/W.
- 5) Administer assembly in reverse order.

*** Checking Solenoid Wiring of Door Lock Switch**

PIN
Arrangement

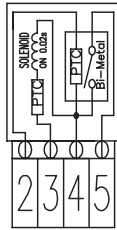
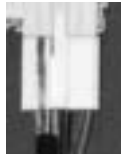

2 3 4 5
(1 does not exist.)

Terminal 3 and 4:
Normal if 156 ~ 234

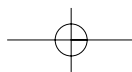
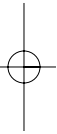
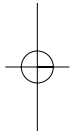

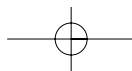

* DF Door Lock S/W Operation

Symptoms	Detailed Symptoms	Cause	Diagnosis of Defect	Solution	Error Mode
Ticking noise	Tick' during initial operation and 'tick-tick' during temporary suspension: 'DF' type only	Normal noise	Normal sound generated during solenoid operation when 'sliding CAM' is locked/ unlocked to close or open door.		-
LE'	Continuous occurrence of 'tick' noise and 'LE': 'DF' type only	Connector loosened	Visually checking connector connection status	Insert connector.	"LE"
		Terminal loosened from connector	Referring to door lock S/W dismantling and checking methods below	Insert connector. S/W 4 or 5 terminal	"LE"
		Door not completely closed	-	Completely close door.	"LE"
		Abnormality in hook of door	-	Replace door AS.	"LE"
		Defect in catch CAM operation	Occurrence of continuous 'tick' noise unlike normal sound	Replace door S/W.	"LE"
	1. 'LE' occurrence without 'tick' noise in 'DF' type	Connector loosened	Visually checking connector connection status	Insert connector.	"LE"
		Terminal loosened from connector	Referring to door lock S/W dismantling and checking methods below	Insert terminal. S/W 2 or 3 terminal	"LE"
		Breaking of solenoid coil	Referring to picture below	Replace door S/W.	"LE"
	Door does not open.	Power failure, forced power off during operation	PCB MICOM' cannot open door in case of power failure or forced power S/W off during operation. Door can be opened in the max. of 5min.		
No power failure and power on		Water in drum	Checking if water level is higher than safety level	Door opens after drainage.	-
		Inside the drum hot	Prevention of door opening to prevent burn caused by hot laundry after drying		
Others		Door does not open normally in case of loosening of connector/ terminal and breaking of solenoid coil during operation. Administer measures after test according to the following method.			

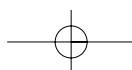

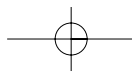

5. HEATER

1) Spec of Heater of Washing Machine

Classification	Wahing
Maker	IRCA
Rated	120V
Consumption	1000W \pm 5%
Power	
Resistance	25.47ohm
Current Density	8.9
Temp. Fuse	184℃
Thermister	Heater built-in
Material	SUS430
Max. Temp.	Water
Part Code	3612801740

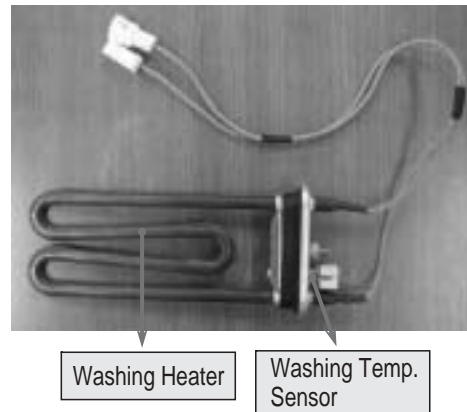

Temp. Fuse of Washing Heater (184 Δ C CUTOFF TYPE)

: Located inside heater to prevent fire, etc. caused by heating without water due to breakdown of water level sensor, etc.

: Cut-off in app. 1min in case of overheating, heater temp. of app. 270 Δ C

: Washing heater must be used under water.

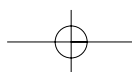

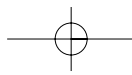

2) Breakdown Diagnosis

Breakdown Symptoms	Cause	Diagnosis	Solution	PCB Error Mode
Washing water not heated (common for drum)	Wiring short	Check for short:	Connect the cut-off part.	"H6"
	Washing heater or temp. fuse short	Check for short: Normal if 23.5~25.7Ω between both terminals of washing heater -> Common for drum	Replace washing heater.	"H6"
	Connector/ terminal loosening	Check for loosening: Common for drum	Insert terminal.	"H6"
	Defect in washing heater temp. sensor	Measuring resistance between both terminals of sensor:	Replace temp. sensor.	"H2"
Overheating of washing water	Defect in washing heater temp. sensor	Measuring resistance between both terminals of sensor:	Replace temp. sensor.	"H2" or "H4"

Heater Replacement

* How to Replace Washing Heater and Temp. Sensor

1. Dismantling Connector



2. Loosening Earth and Heater Nuts



3. Replacing Heater and Temp. Sensor



4. Administer assembly in reverse order and make sure to fasten heater nuts first before the earth nuts.

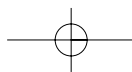

6. BLDC Motor

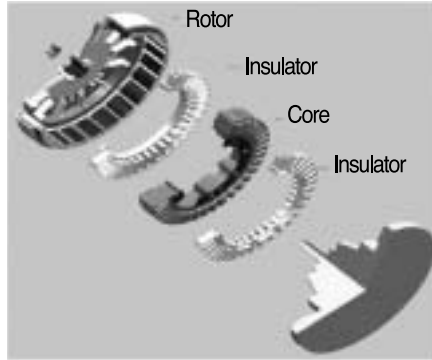

BLDC MOTOR

7. Power Transmission System of BLDC Motor

Magnetic density flow of BLDC Motor

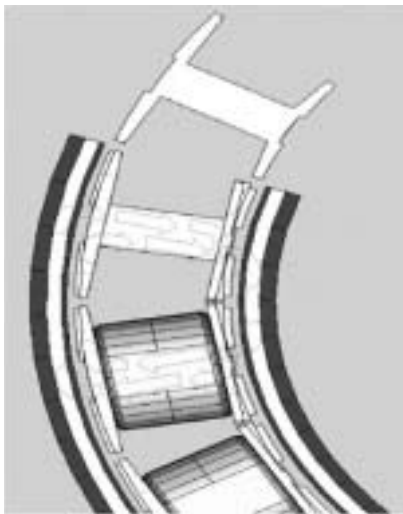

Sequence diagram of BLDC MOTOR

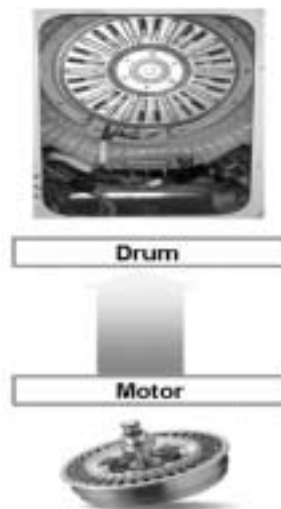

Direct Drive Motor

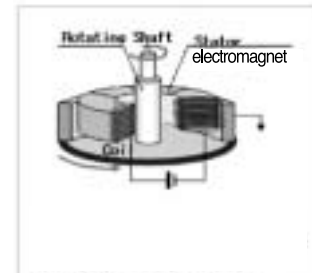

generating high power by rotator (a permanent magnet) and stator (multiple coils)

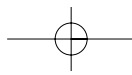

8. Spec.

Classification	Item	BLDC : DD Motor
1. General	Rated Voltage	$V_m = 310$ [Vdc], Hall IC Voltage 5 [Vdc]
	Insulating Structure	Type B, insulator method
	External Appearance	Shaft connection and stator connection structure, Air-gap : 1mm
	No. of Poles	24 poles, Core: 36 slots, Layer: [30mm]
2. Performance	Consumption Power	390[W]±10[%], during washing (picked value)
	RPM	During Washing: 45RPM, During Spin-drying: 1300RPM
	Output Characteristics	Torque: 300Kgf.cm (washing: 45rpm) Current: 1.5A (washing: 45rpm), 2.5A (spin-drying: 800rpm) AC Input Terminal - Washing: 250Wo, Spin-drying: 380Wo
3. Structure	Stator Resistance	ø265x30H U(blue) - V(purple) : 13.8Ω[at 75°C] V(purple) - W(pink) : 13.8Ω[at 75°C] W(pink) - U(blue) : 13.8Ω[at 75°C] cf) Motor resistance at ambient temp. of 0 ~ 35°C 7.04 ~ 8.1Ω
	Rotor	Magnet : 24 segments, bracket, serration
	Hall IC	2-sensor Control Type, Top Central Angle: 7.5 degrees Signal Error Angle (phase difference): 90±5 degrees (based on electric angle)

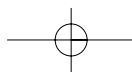

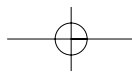

9. Pump Drainage System

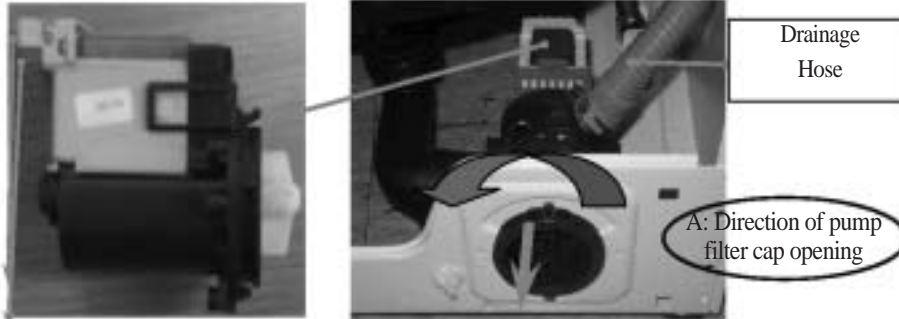

Wire connection terminal Pump filter

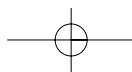
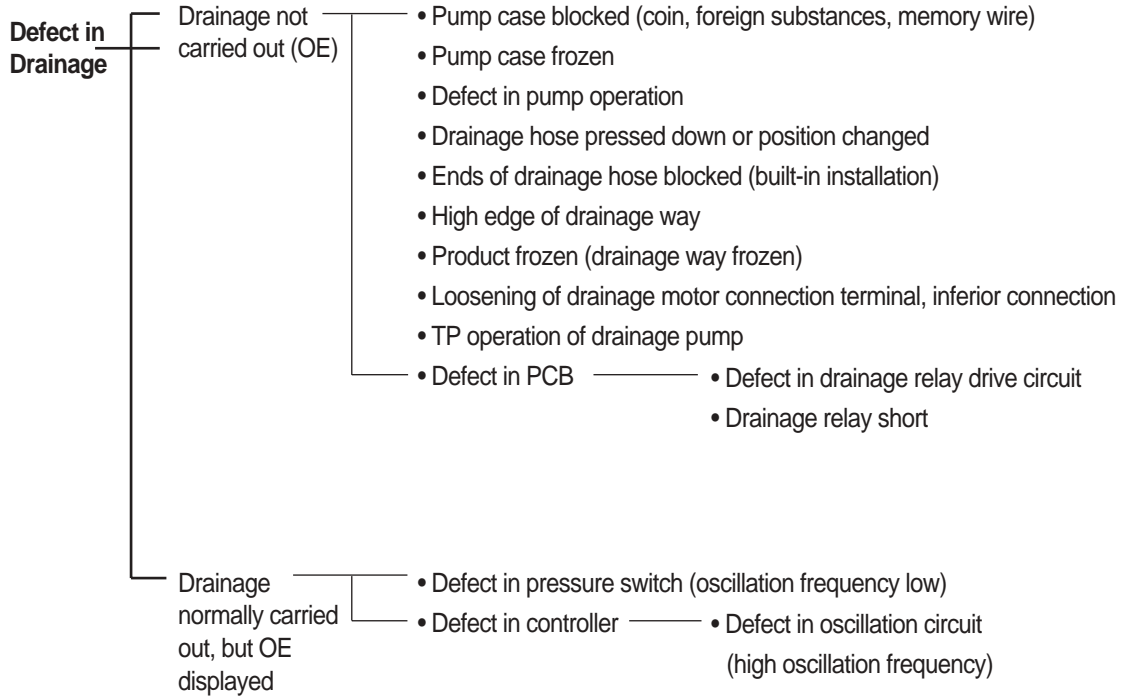

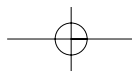

■ Power Defect

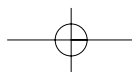
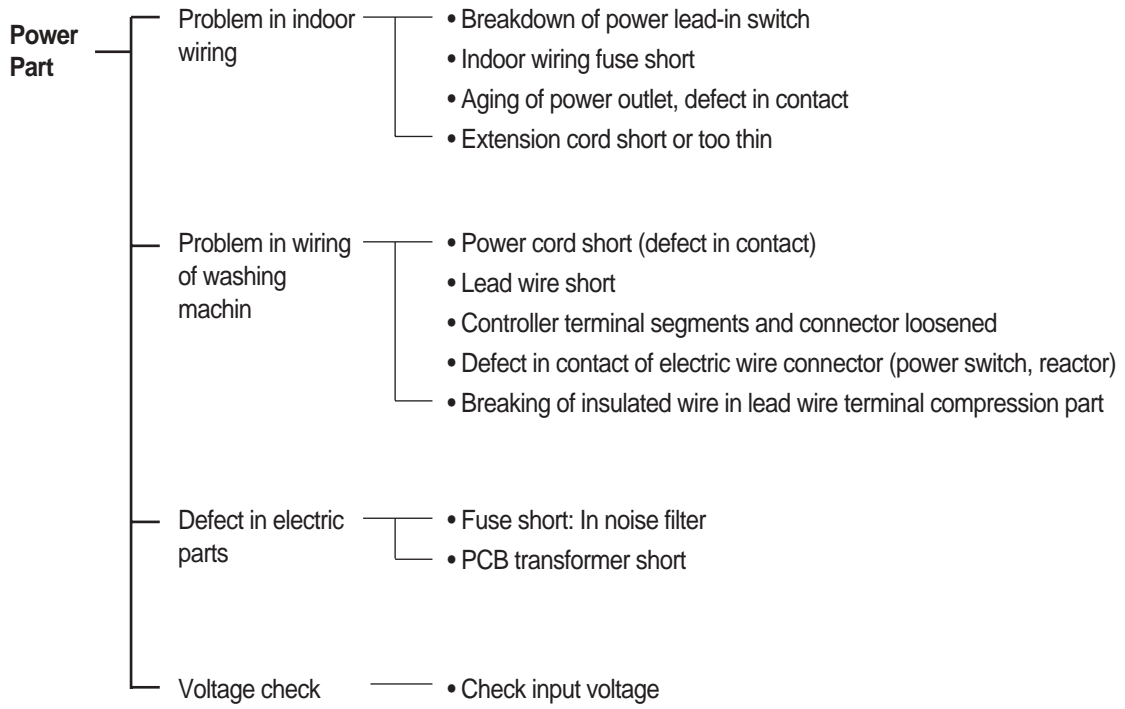

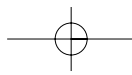

■ Noise Defect

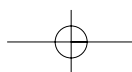
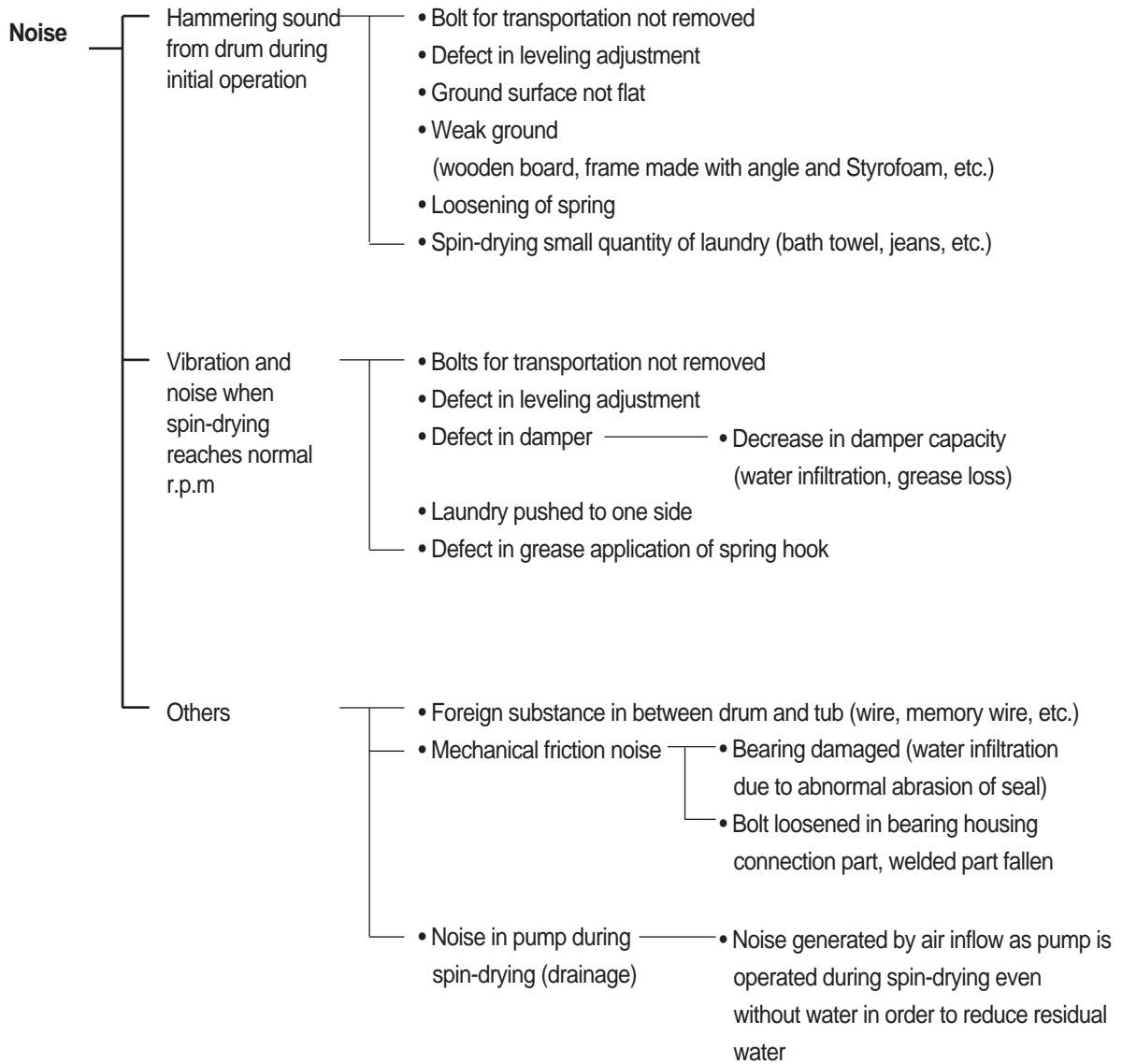

■ Wiring Diagram

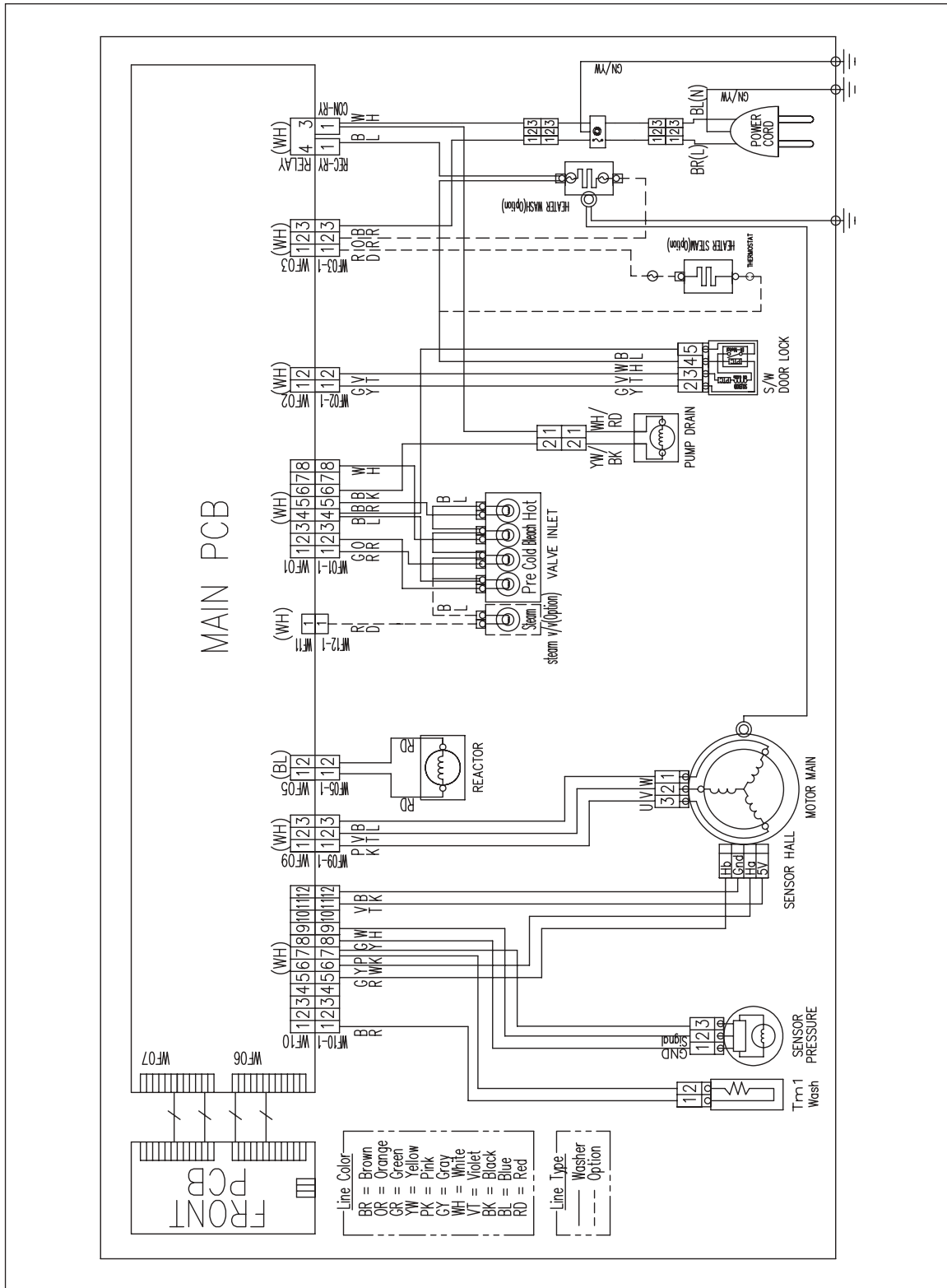

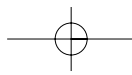

■ Installation

1) Related Parts and Configuration

Item	Configuration	Remarks
FIXTURE UP / DOWN AS		SPECIAL SCREW UP : L= 109mm SPECIAL SCREW DOWN : L=160mm
UNIT SERVICE WRENCH		① FIXTURE UP/DOWN AS를 제거시 사용한다. ② LEG를 조절할 때 사용한다.
LEG ADJUST AS		

2) Installation Procedures

① Remove fixture up/ down AS.

Removal	Remarks
	<ul style="list-style-type: none"> ☞ Remove fixture up/down AS by rotating it in anti-clockwise direction. ☞ Store fixture up/down for use later on. ☞ To assemble fixture up/down AS, rotate it in clockwise direction.

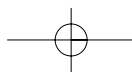

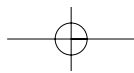

② Insert cap holder (4) into holes created after removing fixture up/down AS as shown in the picture.

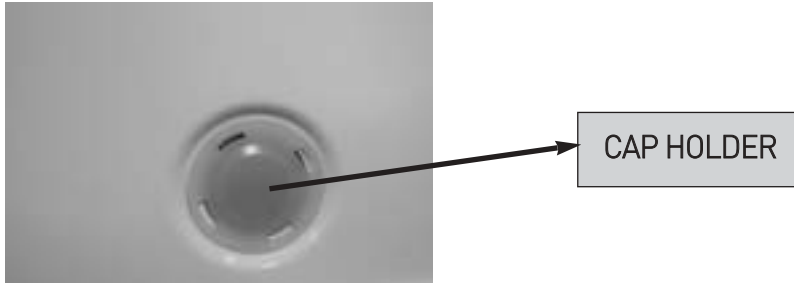

③ Install drum washing machine on flat and solid ground.

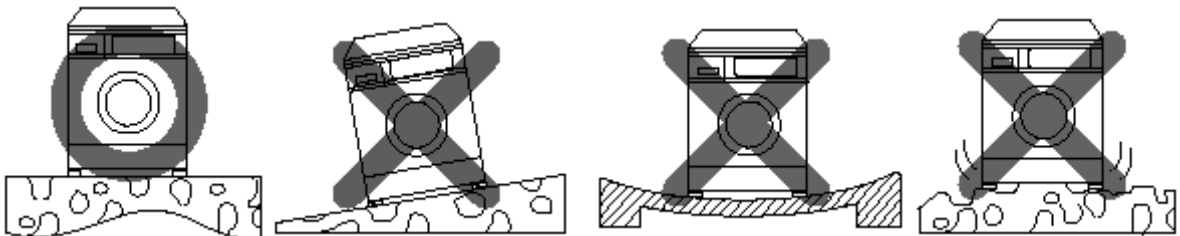

④ Adjust leveling with led adjust AS.

Adjustment	Remarks
	<ul style="list-style-type: none"> ☞ Washing machine is moved upwards by rotating foot of leg adjust AS in clockwise direction. ☞ Washing machine is moved downwards by rotating foot of leg adjust AS in anti-clockwise direction

⑤ Adjust fixture leg to fasten special bolt.

Adjustment	Remarks
	<ul style="list-style-type: none"> ☞ Vibration of washing machine is suppressed by rotating fixture leg in anti-clockwise direction as it fastens special bolt.

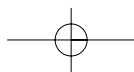

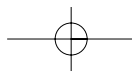

■ Reversing the door

1. Open the door and remove the door by unscrewing 4 bolts holding the hinge.



4. Unscrew the 2 screw on the s/w door lock on the right side of the door and draw out the s/w door lock.

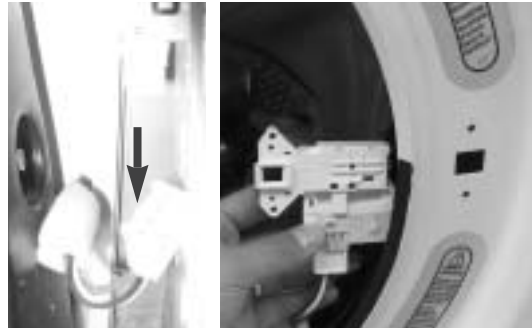

2. Remove the clamp gasket ass'y



5. Draw out the hinge on the left side of door and detach the label on the right side. And attach the RH type label on the left side of door



3. Draw out the shower hose and fix the gasket toward the inside of drum.



6. Insert the hinge of the door and door lock securly and secure the door lock giving attention to direction as following fiures.

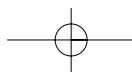

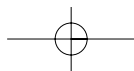

**7. Then insert the socket of door lock as following figure.
And secure the gasket and clamp.**



10. Secure the hinge using the bolts you removed in step 1.



8. Separate the frame door in by unscrewing all screws.

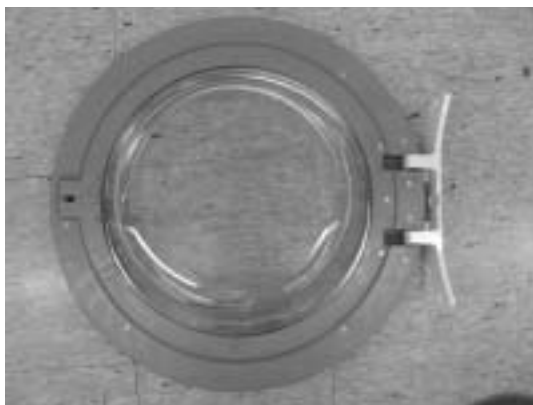

**9. Rotate the door glass 180°C.
Then assemble the DOOR AS.**

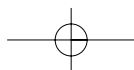
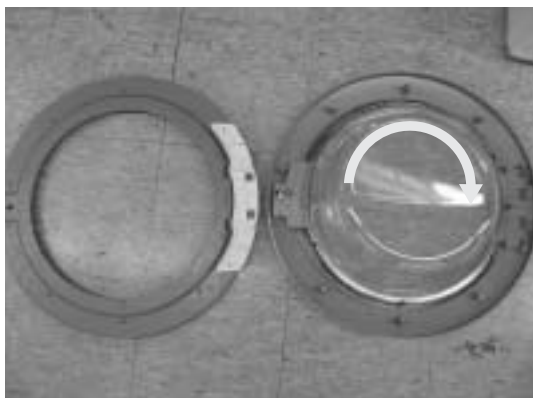

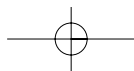

■ DISMANTLING METHOD PER WASHER ASS'Y

INLETBOX ASS'Y

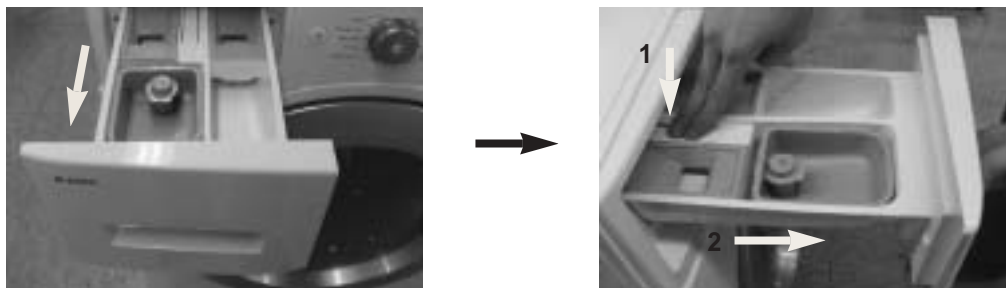

PANEL FRONT ASS'Y

1. Remove 2 screws.
2. Remove panel F.
3. Remove connector.
4. Take caution for damaging hook.

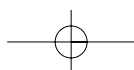
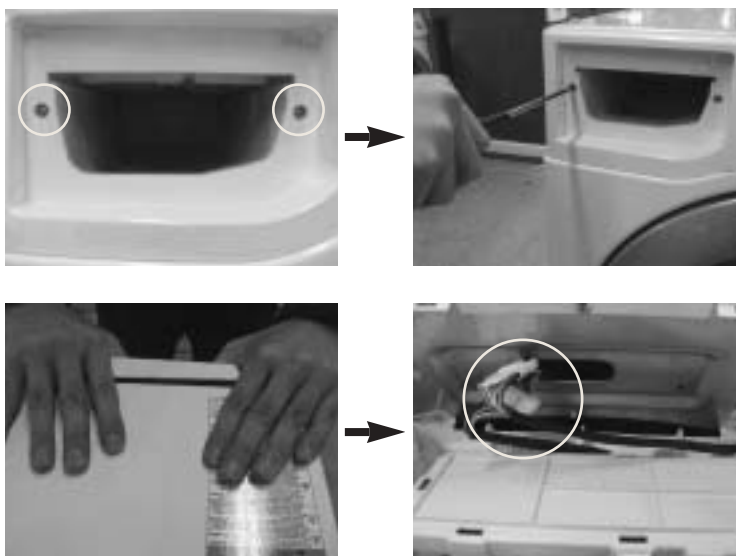

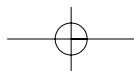
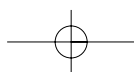
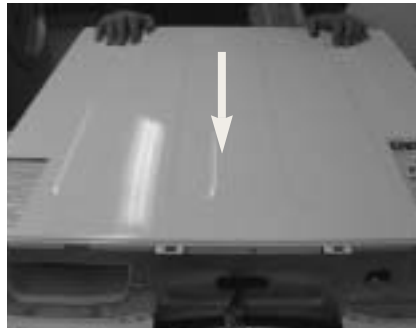

PLATE TOP ASS'Y

1. Remove 3 screws.



2. Remove 4 screws.



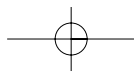

BOX INLET ASS'Y

1. Remove 4 hose clamps.



2. Remove 1 screw and separate inlet box.

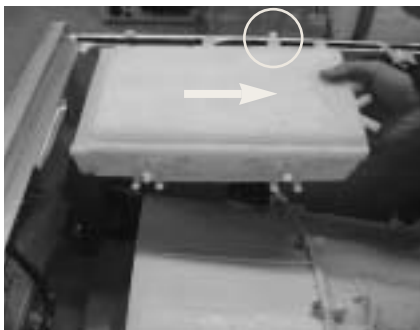

3. Remove and separate hose inlet.

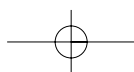

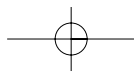

VALVE 3WAY

1. Remove 4 screws.

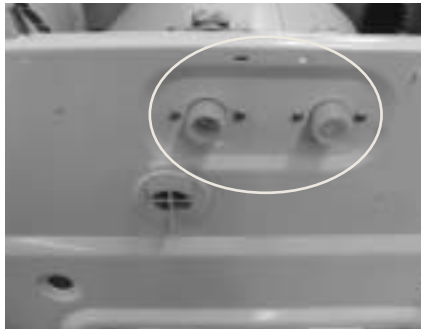

2. Separate 3 connectors.

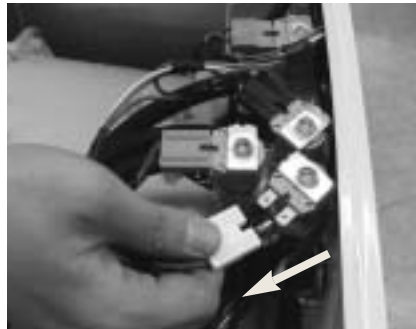

3. Separate 3 hose clamps.

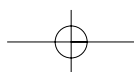
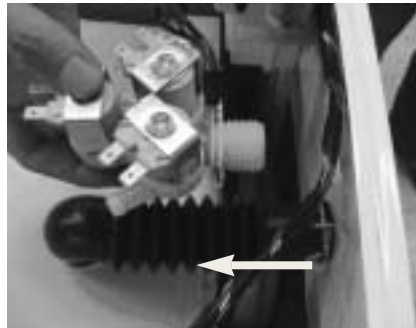
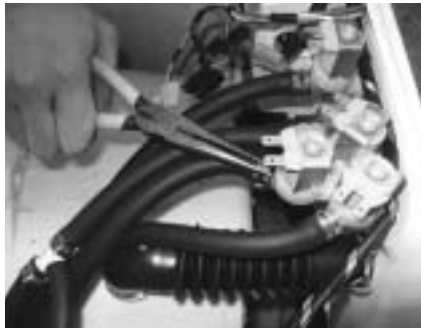

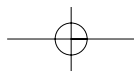

MAIN PCB ASS'Y

1. Separate harness and separate PCB cover.

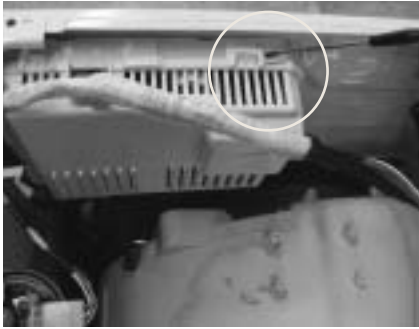

2. Separate connector.



3. Remove 1 screw.

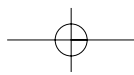
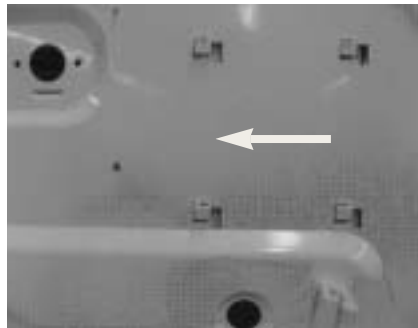
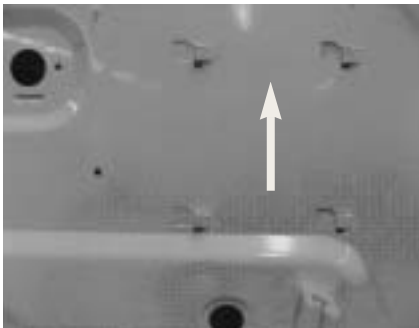

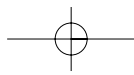

WATER LEVEL SENSOR

1. Remove 1 screw.



2. Separate connector.



3. Separate pressure sensor hose.



COVER BACK

1. Remove 4 screws.

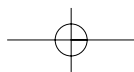

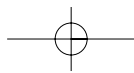

MOTOR ASS'Y

1. Remove 1 bolt to fix stator.
2. Remove motor by separating 6 bolts to fix rotor. (Caution for damaging guide pin)

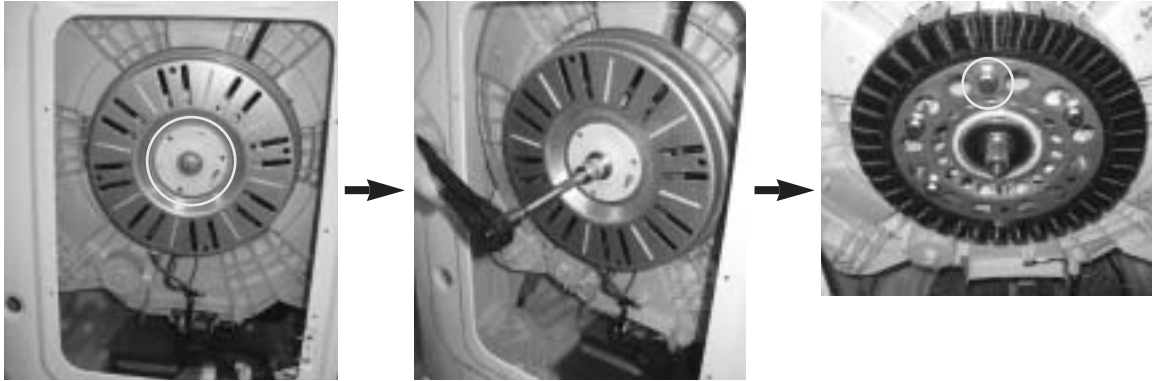

WASHING HEATER

1. Unfasten nut.
2. Remove connector.
3. Remove heater in the direction of arrow.



DAMPER ASS'Y

1. Press the projected edge of sharp part in damper pin.
2. Remove damper pin.

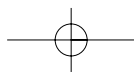

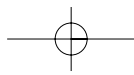

3. Remove damper pin on tub side in the same way and remove damper.



FILTER ISMANTLING (1st Lifter)

1. Push filter in the direction of arrow and pull it out by lifting it in upward direction.

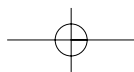

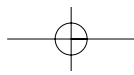

CABINET FRONT ASS'Y

1. Remove clamp gasket.



2. Remove 4 screws.



3. Separate cover and case pump.



4. Remove 1 screw.



5. Lift front in the direction of arrow to open it in forward direction.
6. Separate door switch connector.

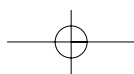

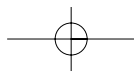

DRAIN PUMP ASS'Y

1. Remove drain hose clamp.



2. Remove 1 screw.



3. Separate connector.



4. Remove pump in the direction of arrow.

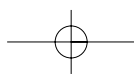
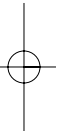
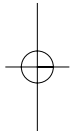
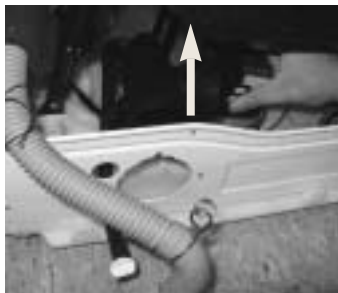

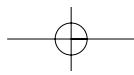

DOOR LOCK SWITCH

1. Remove 2 screws and separate door lock switch.



DOOR ASS'Y

1. Remove 2 screws.



2. Dismantle door after removing 16 screws to fix frame door I.

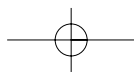

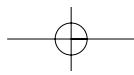

TUB ASS'Y

1. Separate weight balancer after removing 8 screws.

2. Separate motor ass'y



3. Separate tub front after removing 16 screws, 2 spring suspension, 4 damper pin on Base under, Hose Air(T22), Hose Drain(T13) Hose air pressure(T15) and Harness AS on tub rear.

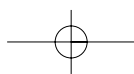
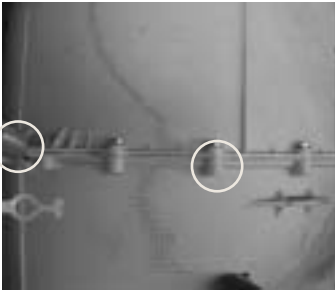

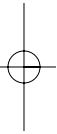
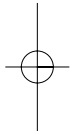
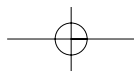

S/M NO. :

DAEWOO ELECTRONICS CORP.

1-2, Jeo-dong 1(il)-ga, Jung-gu, Seoul, Korea
C.P.O. BOX 8003 SEOUL, KOREA
TELEX: DWELEC K28177-8
CABLE: "DAEWOOELEC"

PRINTED DATE: Mar. 2010

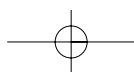

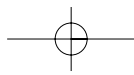

ABOUT THIS MANUAL

VISION CREATIVE, INC.

서울 중로구 통의동
6번지 이룸빌딩 4층

담 당	황의근 님	
MODEL	DWD-WD125*, WD135*, WD135*02 (S/M)	
접 수	2009.07.29	
일 정	1차	
	2차	
	3차	
	4차	
	5차	
제 판	한	인 쇄
규 격		
<p>MEMO 총 80p</p> <p>09.07.29-표지, 표지뒤, 1p, 5p, 8p, 9p, 10p, 11p, 12p, 13p, 14p, 15p, 16p, 17p, 19p, 20p, 21p, 30p, 34p, 38p, 39p, 45p, 46p_ 신규 23p</p> <p>09.07.31-17p(페이지추가), 21p, 36p, 37p, 38p, 39p(페이지 추가), 40p, 48p, 76p 수정_ 신규 9p</p> <p>09.10.23-표지, 표지뒤, 2p, 20p, 68p 수정_ 신규 5p</p> <p>10.02.25-8p, 11p 수정_ 신규 5p (안정희 님)</p> <p>10.03.18-표지, 표지뒤, 8p 수정_ 신규 3p (안정희 님)</p> <p>11.03.22-11p 수정_ 신규 1p (안정희 님)</p>		

연락처

VISION 담당 방문수

TEL: 730-0660 FAX: 730-3788

