



Model No. RGE(P)480 / RGE(P)510
Factory No. RGE(P) 480 / RGE(P)510

Service Manual

Refrigerator

√ Caution

In this manual, some parts can be changed for improving their performance without notice.
So, If you need the latest parts information, please visit and refer to PPL (Parts Price List)
In Service Information Center.(<http://svc.dwe.co.kr>)

CONTENTS

WARNINGS AND PRECAUTIONS FOR SAFETY -----	3
1. SPECIFICATION -----	4
2. NAME OF EACH PART -----	5
3. COLD AIR CIRCULATION -----	6
4. WIRING DIAGRAM -----	8
5. PCB CIRCUIT DIAGRAM -----	11
6. HOW TO REPLACE THE PARTS -----	14
7. PCB CONTROL FUNCTION -----	24
8. EXPLODE VIEW AND PARTS LIST -----	46

WARNINGS AND PRECAUTIONS FOR SAFETY

Please observe the following safety precautions in order to use safely and correctly the refrigerator and to prevent accident and danger during repair.

1. Be care of an electric shock. Disconnect power cord from wall outlet and wait for more than three minutes before replacing PCB parts.
Shut off the power whenever replacing and repairing electric components.
2. When connecting power cord, please wait for more than five minutes after power cord was disconnected from the wall outlet.
3. Please check if the power plug is pressed down by the refrigerator against the wall.
If the power plug was damaged, it may cause fire or electric shock.
4. If the wall outlet is over loaded, it may cause fire.
Please use its own individual electrical outlet for the refrigerator.
5. Please make sure the outlet is properly earthed, particularly in wet or damp area.
6. Use standard electrical components when replacing them.
7. Make sure the hook is correctly engaged.
Remove dust and foreign materials from the housing and connecting parts.
8. Do not fray, damage, machine, heavily bend, pull out or twist the power cord.
9. Please check the evidence of moisture intrusion in the electrical components.
Replace the parts or mask it with insulation tapes if moisture intrusion was confirmed.
10. Do not let the customers repair, disassemble and reconstruct the refrigerator for themselves.
It may cause accident, electric shock, or fire.
11. Do not store flammable materials such as ether, benzene, alcohol, chemicals, gas, or medicine in the refrigerator.
12. Do not put flower vase, cup, cosmetics, chemicals, etc., or container with full of water on the top of the refrigerator.
13. Do not put glass bottles with full of water into the freezer.
The contents shall freeze and break the glass bottles.
14. When you scrap the refrigerator, please disconnect the door gasket first and scrap it where children are not accessible.

1. SPECIFICATION

Item		RGE48	RGE51
ISO Gross Volume (Li)	Total	507 Li	533 Li
	Freezer Compartment	144 Li	144 Li
	Fresh Food Compartment	363Li	389 Li
ISO Storage Volume (Li)	Total	483Li	509 Li
	Freezer	126Li	126 Li
	Refrigerator	357 Li	383 Li
Weight	NET	71Kg	72Kg
	PACKING	78Kg	79Kg
External Dimension (W x D x H)	NET	731 mm X 728 mm X 1764 mm	731 mm X 728 mm X 1834 mm
	PACKING	768 mm X 778 mm X 1820 mm	768 mm X 778 mm X 1890 mm

2. Name Of Each Part

Non Dispenser Model

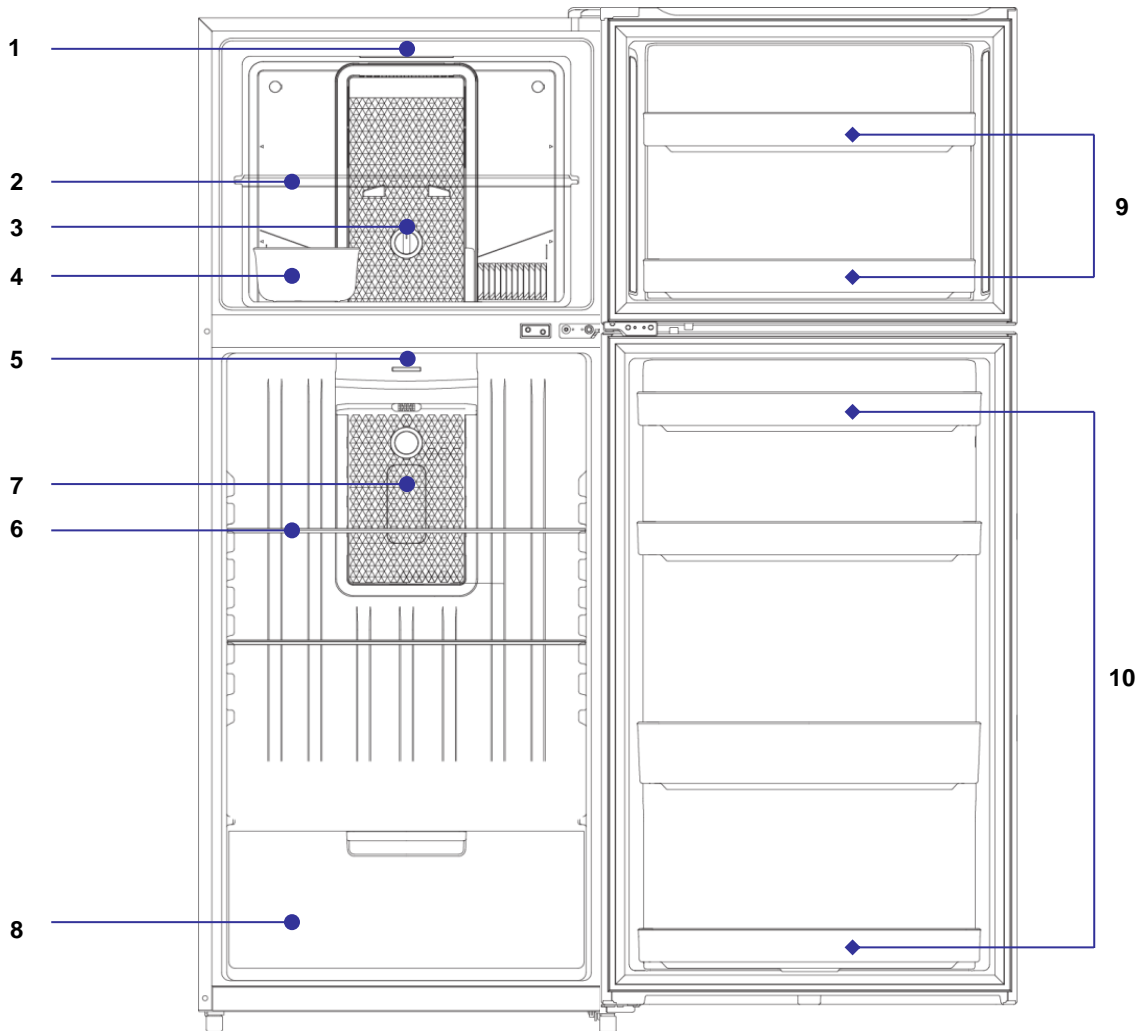

1. Freezer Compartment LED Lamp (Option)	6. Fresh Food Compartment Shelves
2. Freezer Compartment Shelf	7. Fresh Food Compartment Sensor
3. Freezer Compartment Temperature Controller	8. Vegetable Case
4. Case Icing(Optional)	9. Freezer Compartment Pockets
5. Fresh Food Compartment LED Lamp	10. Fresh Food Compartment Pockets

Dispenser Model

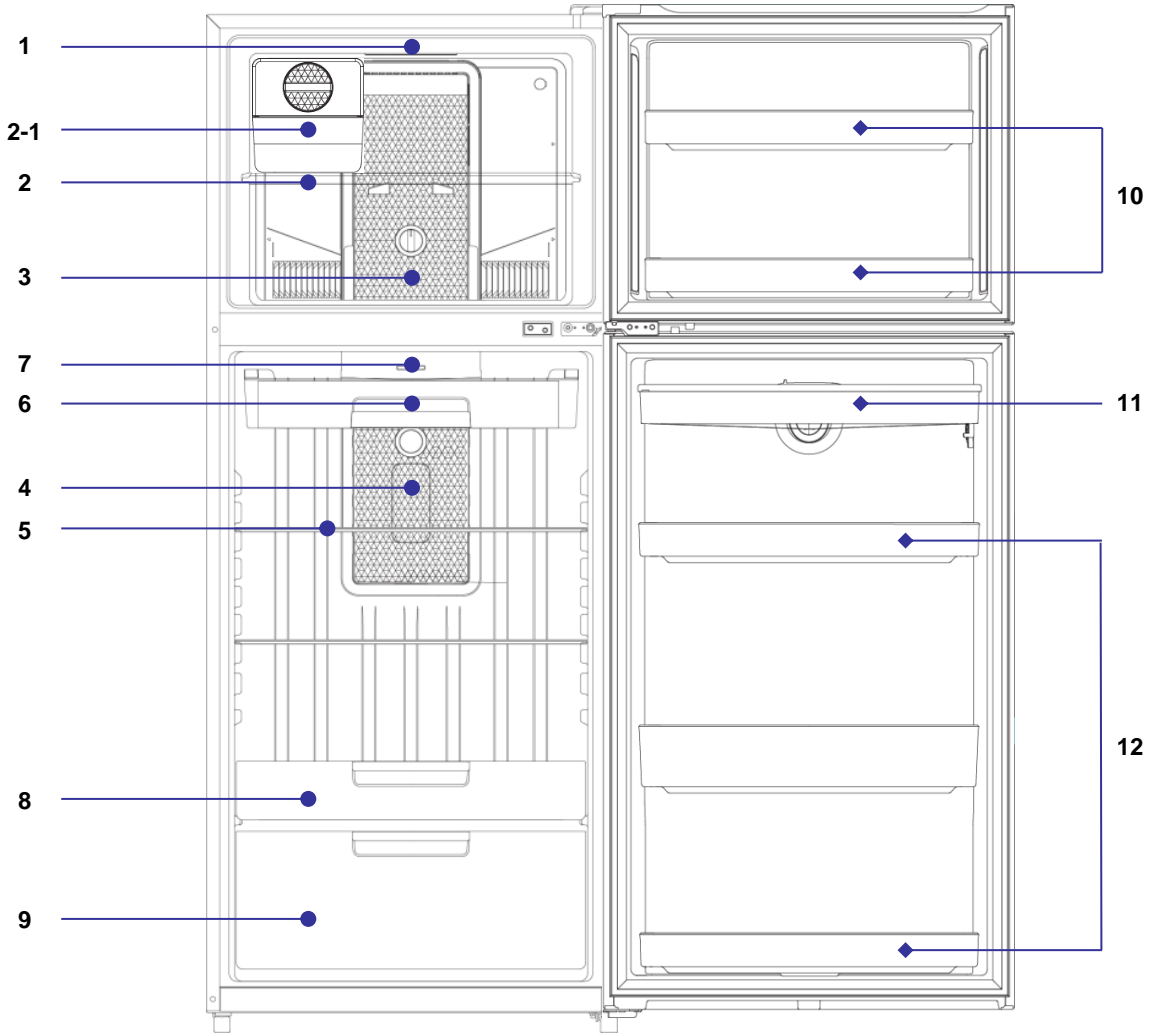

1. Freezer Compartment LED Lamp (Option)	7. Fresh Food Compartment Sensor
2. Freezer Compartment Shelf	8. Fresh Case(Optional)
2-1. Twist Ice Maker(Optional)	9. Vegetable Case
3. Freezer Compartment Temperature Controller	10. Freezer Compartment Pockets
4. Fresh Food Compartment Lamp	11. Water Tank (Option)
5. Fresh Food Compartment Shelves	12. Fresh Food Compartment Pockets
6. Utility Case(Optional)	

3. Cold Air Circulation

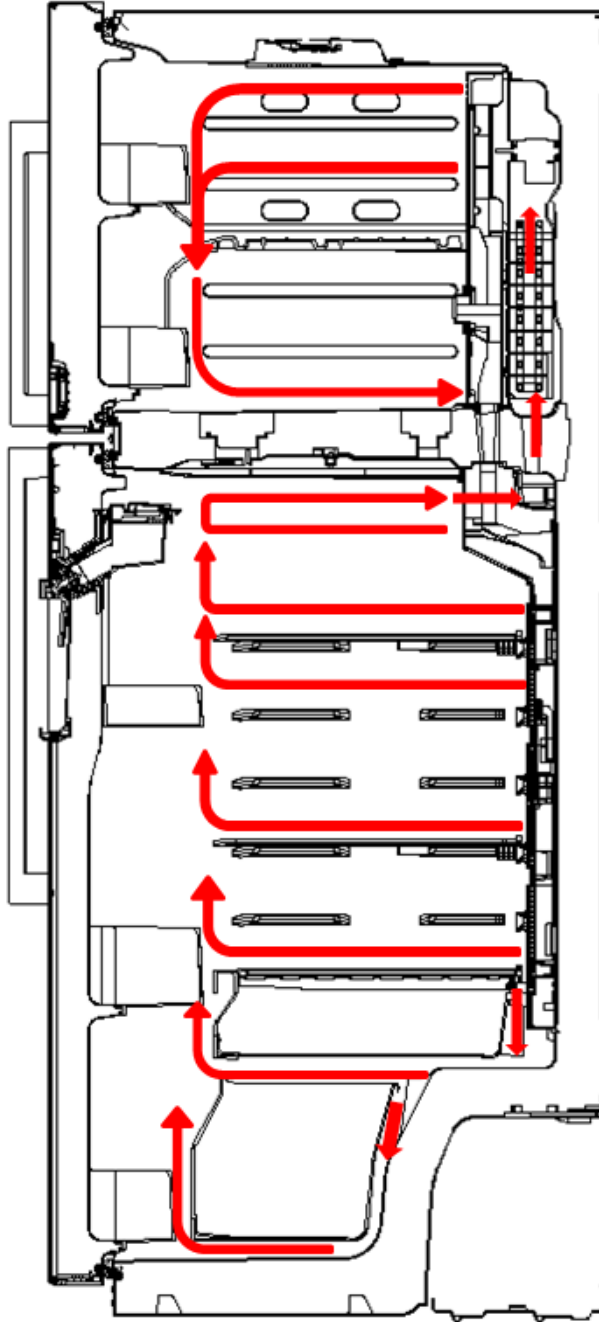

4. Wiring Diagram
1-1 : DIAL TYPE

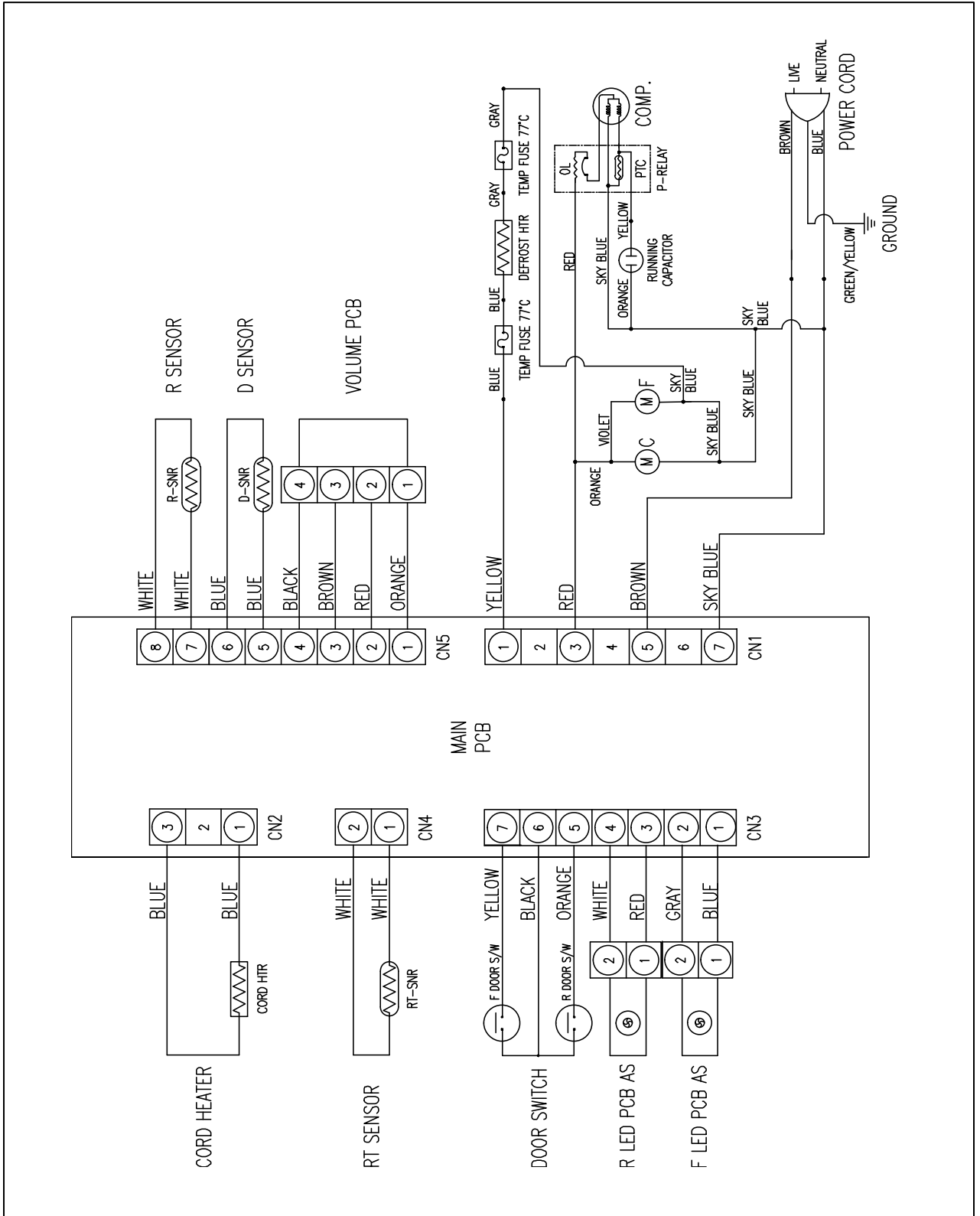

4. Wiring Diagram
1-2 : FCP TYPE

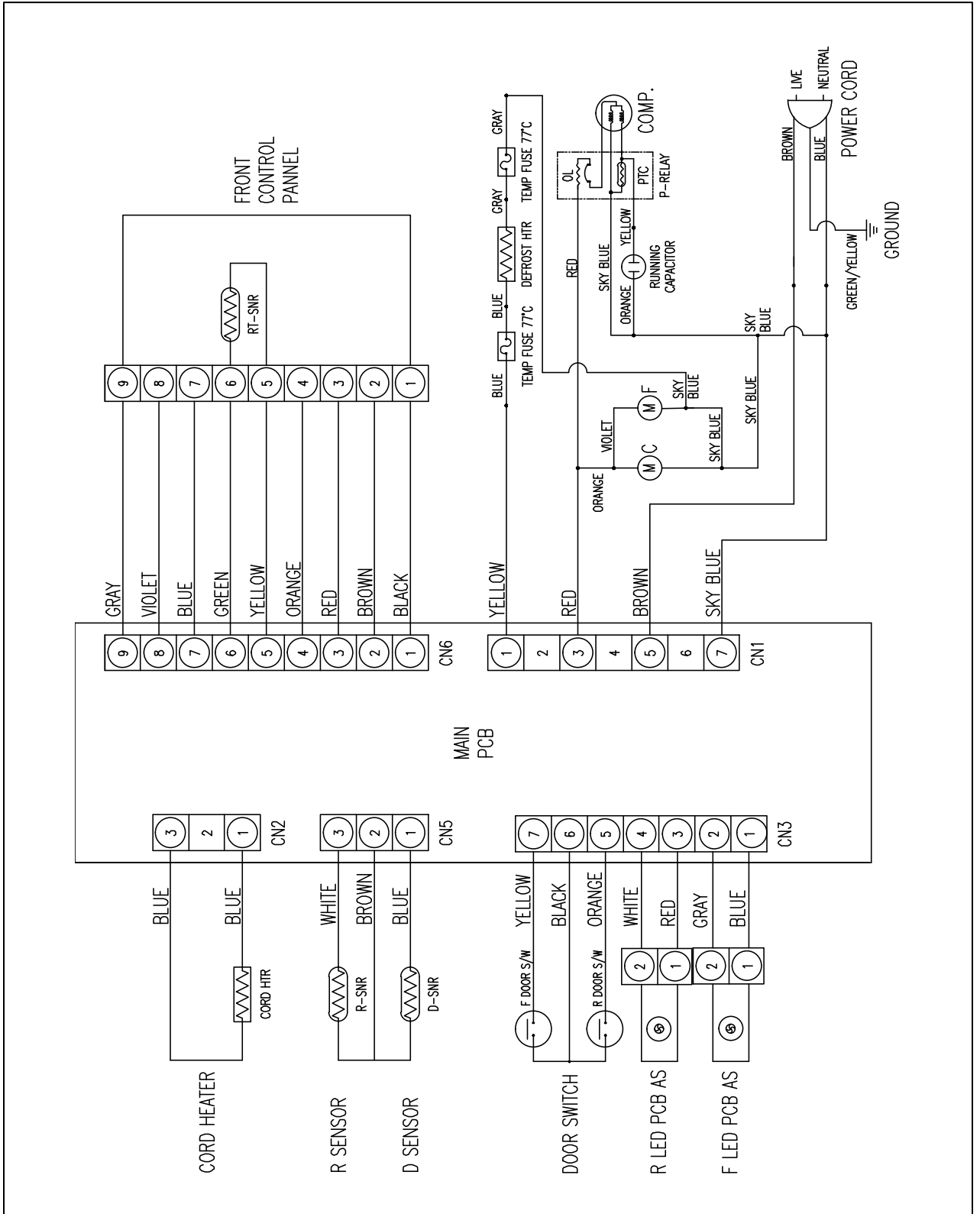

4. Wiring Diagram
1-2 : Dial Inverter TYPE

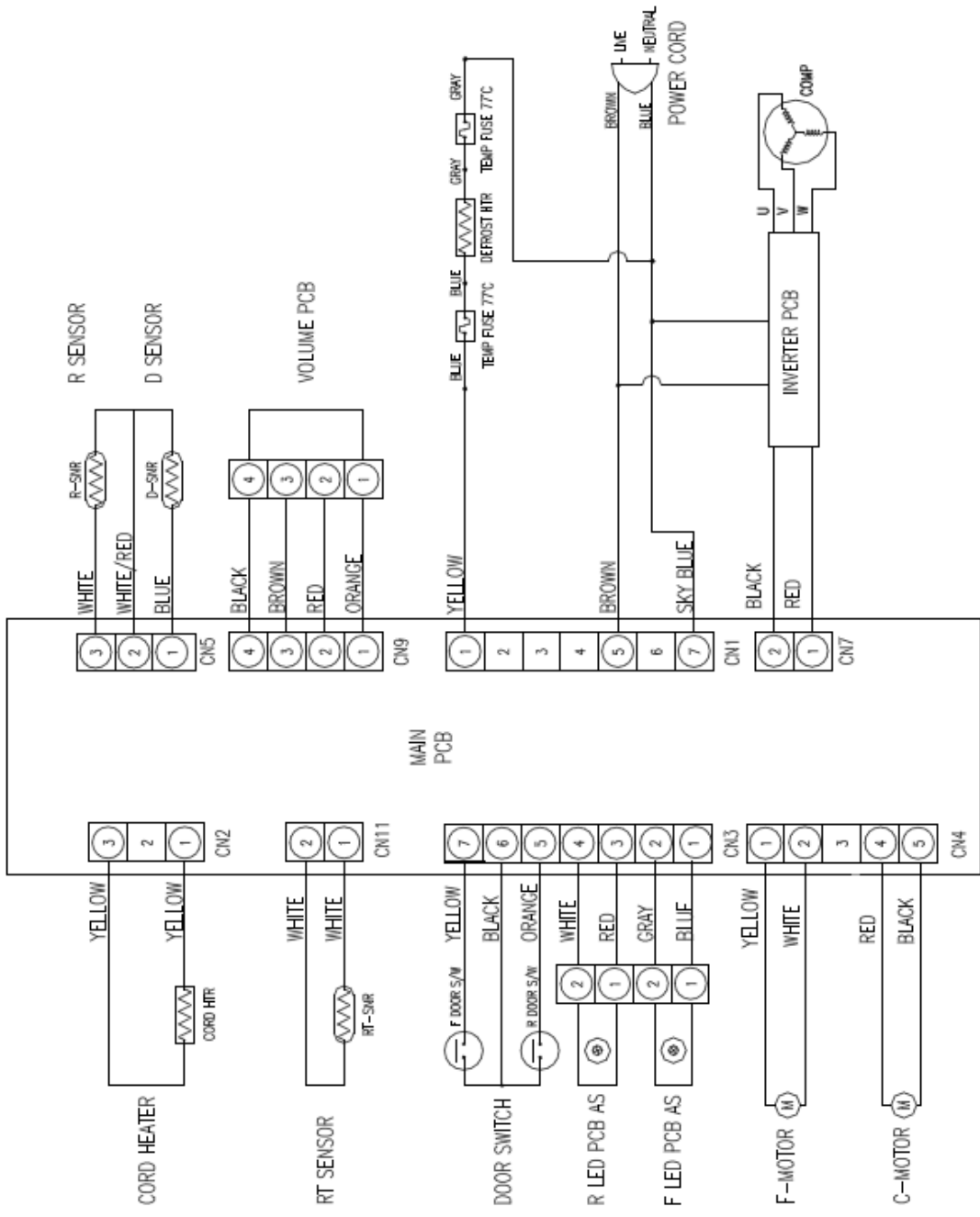

5. PCB CIRCUIT DIAGRAMS

1-1 : DIAL Type

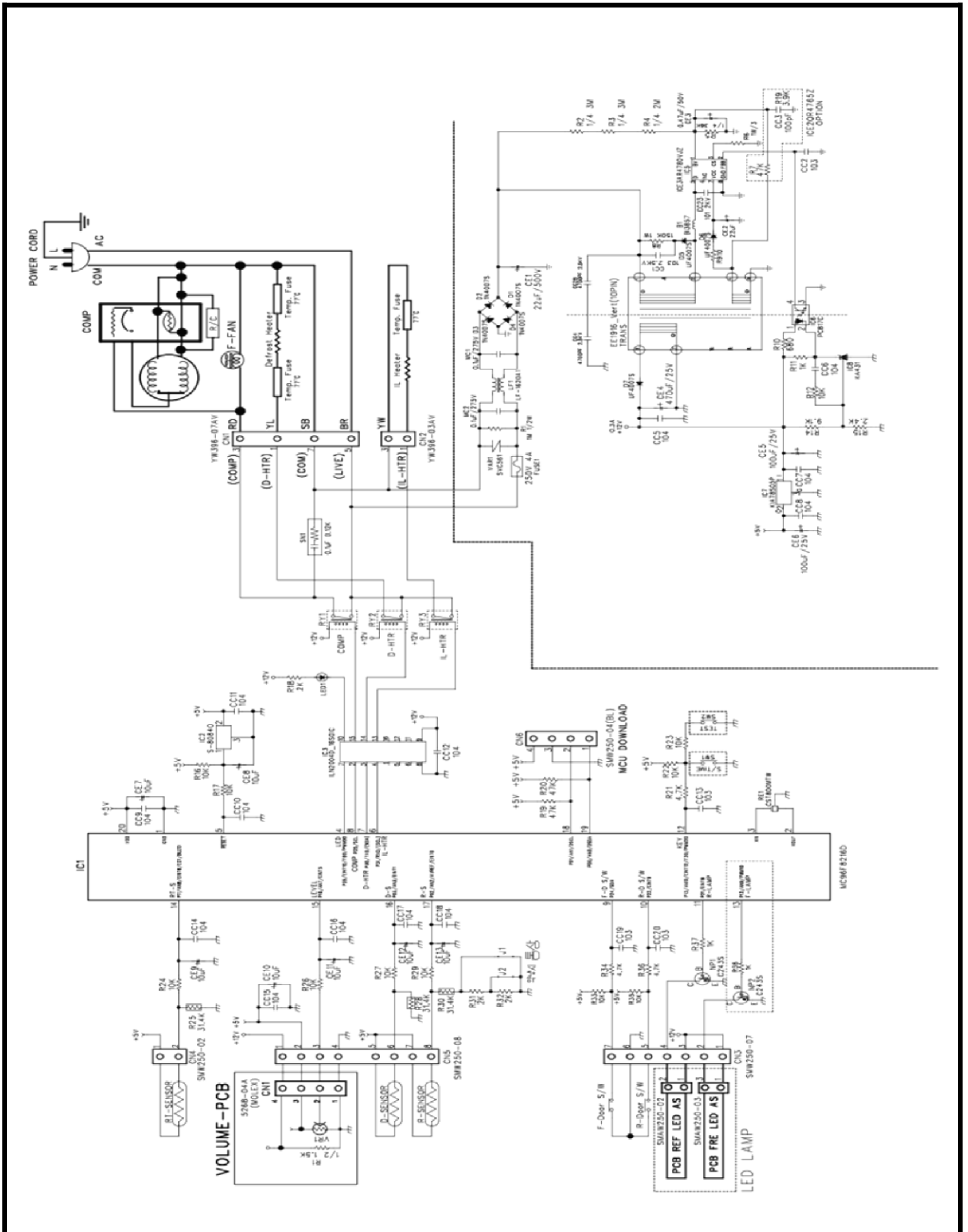

5. PCB CIRCUIT DIAGRAMS 1-2 : FCP TYPE

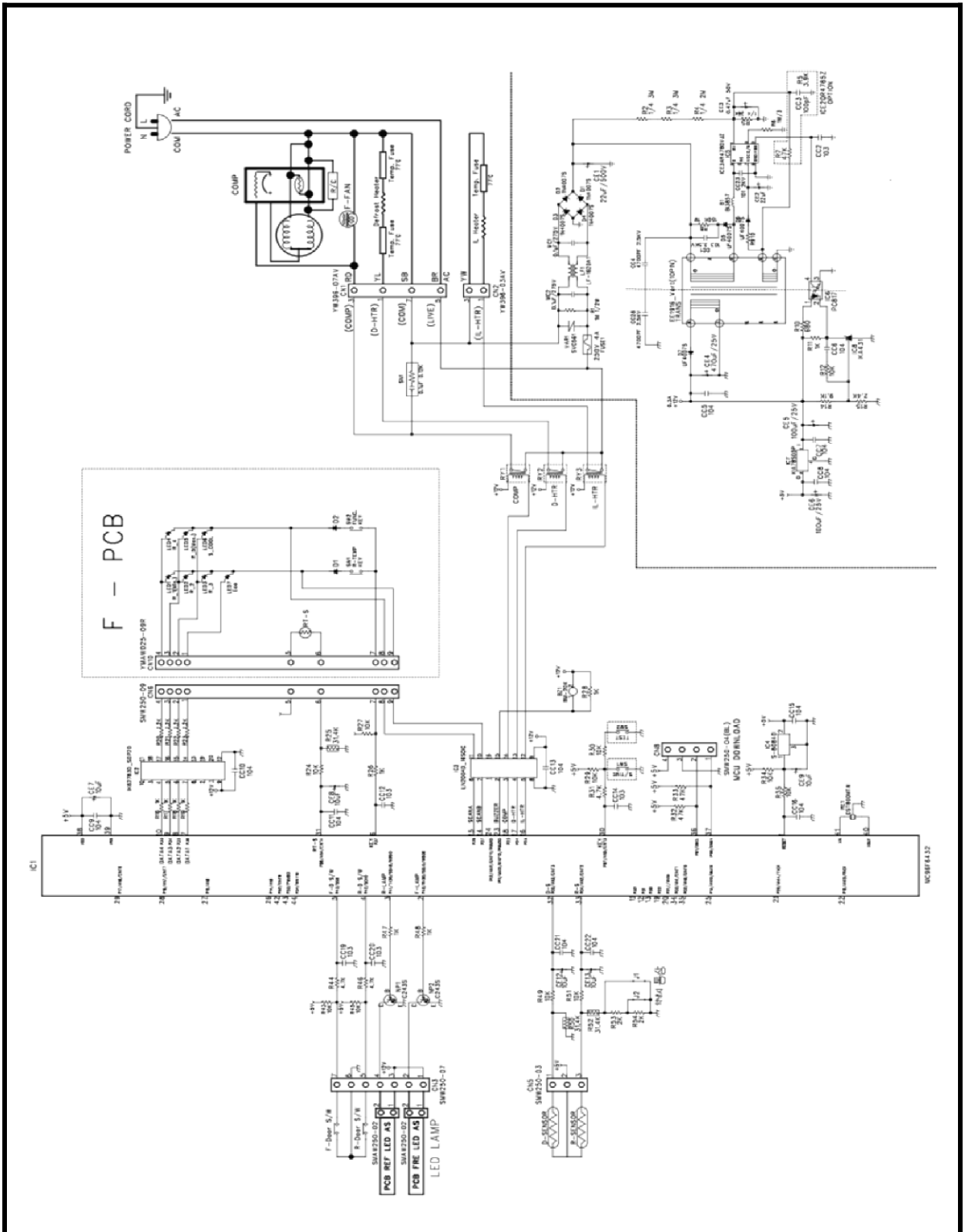



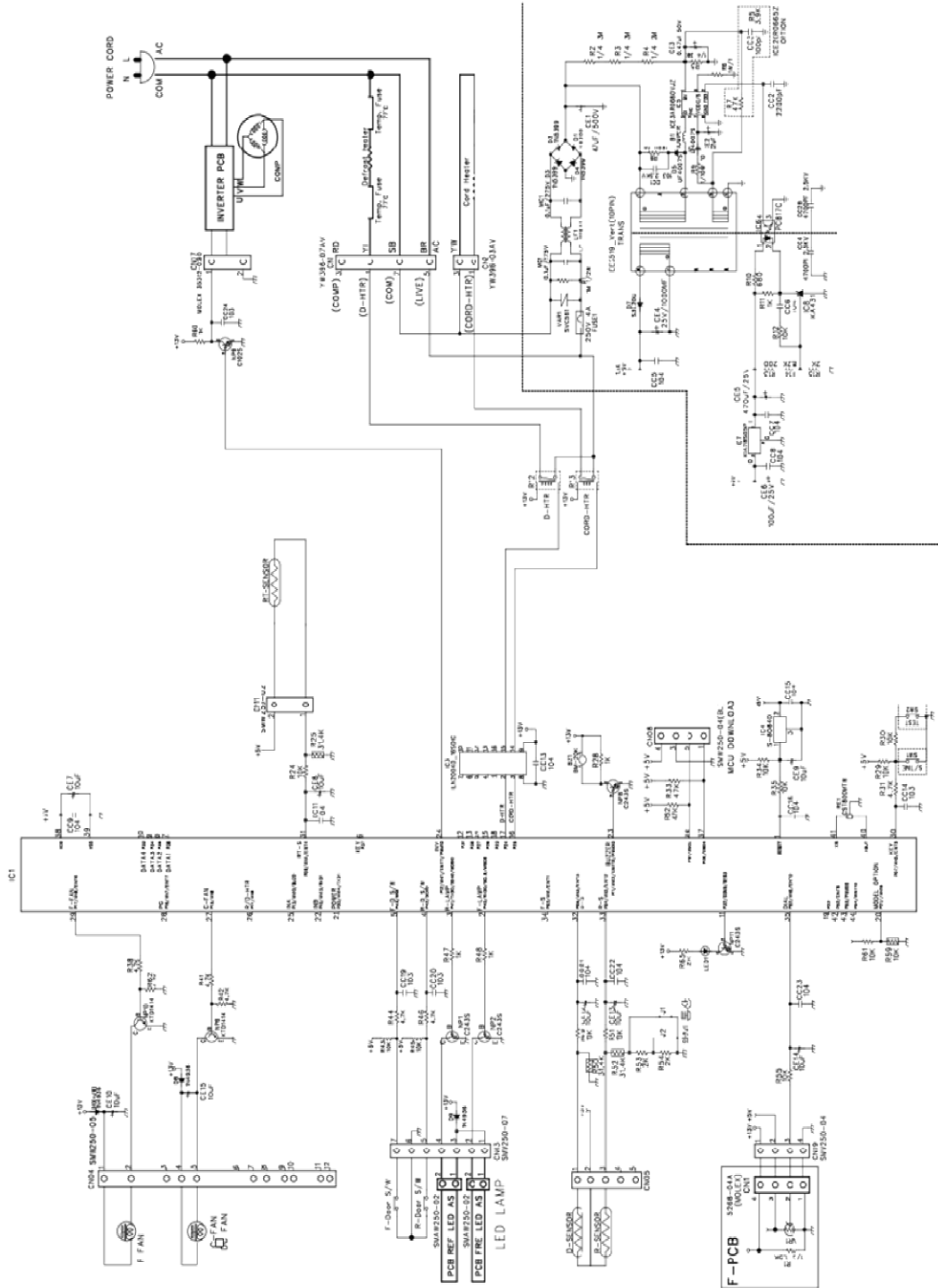

5. PCB CIRCUIT DIAGRAMS
1-3 : . Dial Inverter Type





6. How To Replace The Parts



6-1. Freezer Louver Part

No	Photos	Description
1		<ul style="list-style-type: none">- Remove 'Freezer Shelf' at first.
2		<ul style="list-style-type: none">- Remove 2 Cap Screws.- Remove 2 screws on 'Freezer Louver'.
3		<ul style="list-style-type: none">- Pull forward the 'Freezer Louver'.- Then disconnect 'Freezer Motor'.
4		<ul style="list-style-type: none">- Disassemble the 'Cover Fan F AS'.- Be careful not to damage the hook.

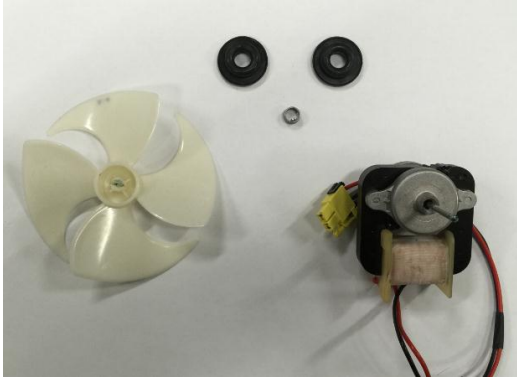

6-2. Freezer Motor As



No	Photos	Description
1		<ul style="list-style-type: none">- Remove 4 screws.- Remove the Top cover motor screw
2		<ul style="list-style-type: none">- Remove Clamp Fan with pliers and then disassemble 'Fan' with (-) driver.
3		<ul style="list-style-type: none">- Now disassemble the 'Freezer Motor'.

6-3. Evaporator

No	Photos	Description
1		<p>- The evaporator configured as shown in the picture.</p>
2		<p>- Pull forward the evaporator and pipes. - Be careful not to bend the pipes.</p>
3		

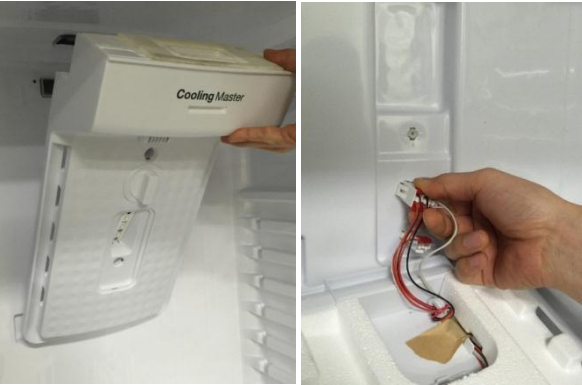

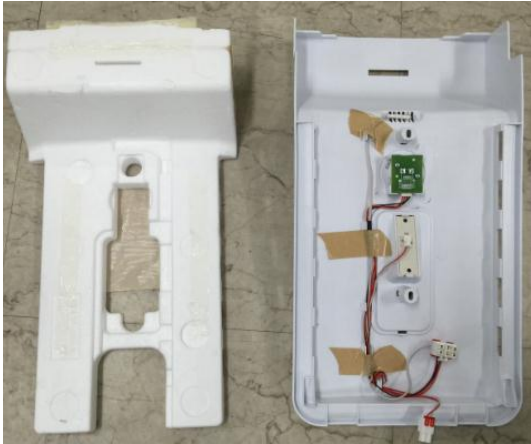
6-4. M/Flow-Duct

No	Photos	Description
1		<ul style="list-style-type: none">- Remove 'SHELF R'- Remove 'CASE FRESH'- Remove 'Shelf fresh case as'
2		<ul style="list-style-type: none">- Remove 'Window R Lamp ' with (-) driver.- Remove 'Cap 2 Screws' with (-) driver.
3		<ul style="list-style-type: none">- Pull forward the 'Cover M/Duct As'- Then disconnect ' R Lamp' and ' R Sensor'

No	Photos	Description
4		<ul style="list-style-type: none"> - Stripping the seal material attached as a photo
5		<ul style="list-style-type: none"> - Pull the Insu m/duct and remove the Cover m/duct as
6		<ul style="list-style-type: none"> - Remove the hook on the LED lamp. - Disconnect 'LED Lamp' lead wire. - Then disconnect ' R Lamp' and ' R Sensor'

6-5. LED Lamps



Freezer compartment LED lamp

No	Photos	Description
1		<ul style="list-style-type: none">- Remove 'Freezer Lamp Window'.- Be careful not to damage the hook.
2		<ul style="list-style-type: none">- Remove the hook on the LED lamp.- Disconnect 'LED Lamp' lead wire.

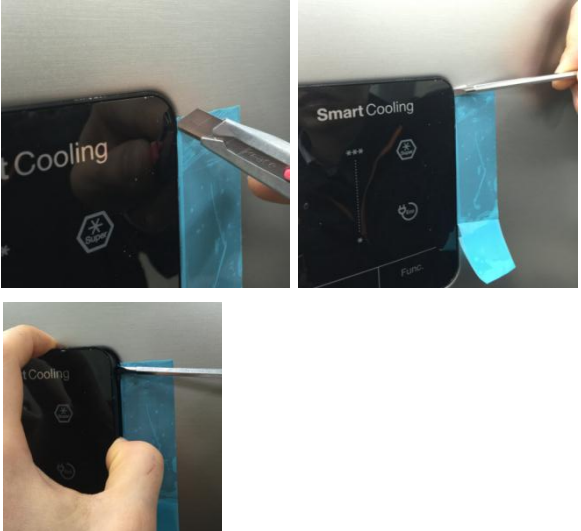

6-6. Handle Installation

No	Photos	Description
1		<p>- Attach the 4 Screws the bolt on the cabinet.</p>
2		<p>- Align Freezer door handle with fixture and pull the handle down. (Be careful the direction)</p>
3		<p>- Align Fresh Food compartment door handle with fixture and pull the handle down (Be careful the direction)</p>



6-7. Front PCB

No	Photos	Description
1		<p>- Attach OPP tape on side of 'Front PCB' to prevent scratch.</p>
2		<p>- Disassemble 'Front PCB' with using flathead tools as next picture.</p>
3		<p>- Disconnect 'Front PCB' lead wire.</p>

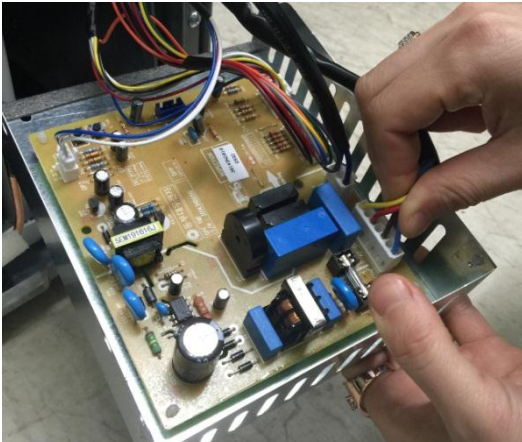
6-8. MAIN PCB

No	Photos	Description
1		- Remove the screws and disassemble the 'Grille As'.
2		- Remove the screws and disassemble the 'Box Main PCB As'.
3		- Disconnect Housings on the 'Main PCB'.

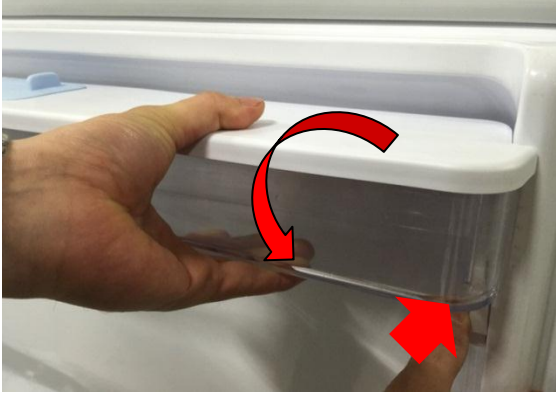
6-9. Water Dispenser

No	Photos	Description
1		<p>- Push the 'Stopper Water Tank', then pull and remove the 'Water Tank As'.</p>
2		<p>- Remove the screws on the bottom of 'Panel Dispenser As'.</p>
3		<p>- Disassemble the 'Panel Dispenser As'.</p>

7. PCB CONTROL FUNCTION

7-1. SPECIFICATIONS

구분		R-Control							
		240L		13cuft		34~400L		48~510L	
Type		Dial	Dial	Fcp	Dial	Fcp	Dial	Fcp	Dial Inverter
F U N C T I O N S	Super Cooling	-	-	O	-	O	-	O	-
	Eco Mode	-	-	O	-	O	-	O	-
	FCP Lock	-	-	-	-	-	-	-	-
	Buzzer	-	-	O	-	O	-	O	O
E L E C T R O N I C A L P A R T S	Comp		Normal						Inverter
	Heater	Defrost	O	O	O	O	O	O	O
		IL	O	O	O	O	O	O	O
	Motor (DC)	F	(AC)	(AC)	(AC)	(AC)	(AC)	(AC)	O
		C	(AC)	(AC)	(AC)	(AC)	(AC)	(AC)	O
	Sensor	R	O	O	O	O	O	O	O
		D	O	O	O	O	O	O	O
		RT	O	O	O	O	O	O	O
	Door S/W	F	-	-	O	O	O	O	O
		R	O	O	O	O	O	O	O
Lamp	F	-	-	O	O	O	O	O	
	R	O	O	O	O	O	O	O	
Etc.	PCB Location	Machine Room	Back	Machine Room	Machine Room	Machine Room	Machine Room	Machine Room	
	RT-S Location	Dial Type - Hinge, FCP Type – Front PCB Board							

* AC fan motor is interlocked with comp, No PCB controls it.

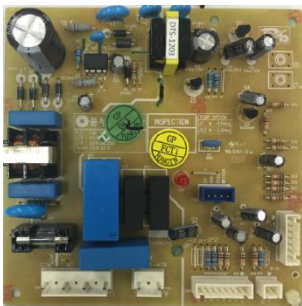

<Dial Type PCB>

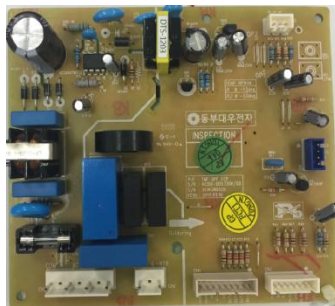

<Fcp Type PCB>

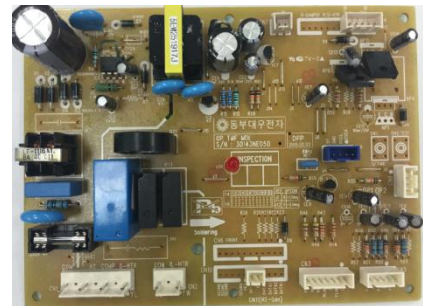

<Dial Inverter Type PCB>

7-2. Control Panel

A. Panel graphic

Dial Type & Dial Inverter Type

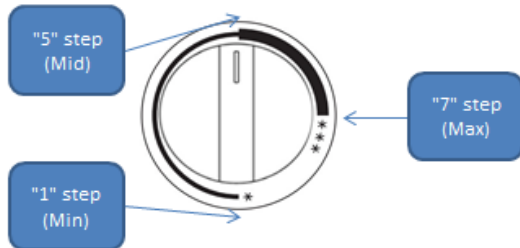

Fcp Type

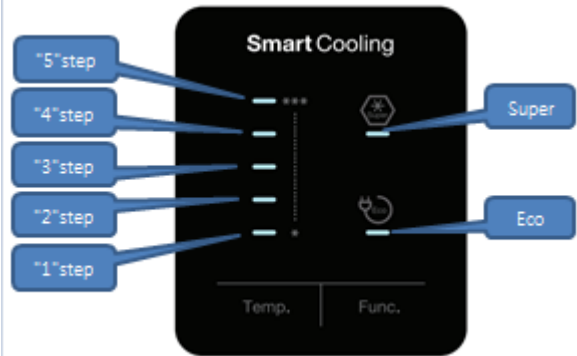

B. How to use Panel

Dial Type & Dial Inverter Type

1. Volume Dial : it controls temperature of refrigerator by step.

- ① How to set temperature : Turn round "Volume Dial Knob".
- ② Temperature setting sequence : 1step → 2step → 3step → 4step → 5step → 6step → 7step
(Min) (Mid) (Max)

Fcp Type

1. Temp Key : it controls temperature of refrigerator by step.

- ① Default : "3step"
- ② How to set temperature : Push "Temp." key
- ③ Temperature setting sequence : 1step → 2step → 3step → 4step → 5step
(Min) (Mid) (Max)

2. Func Key : It controls special Mode of refrigerator.

- ① Default : Mode Off
- ② How to change Mode : Push "Func." key
- ③ Mode change sequence : Mode Off -> Super Mode -> Eco Mode (repeat)

7-2. Control Panel

C. Display

Fcp Type

1. Operation

- ① At normal state, display led is on by 100% brightness.
- ② When it passes 1minutes without key operation or door operation, all led is off.
- ③ When there is operation for key or door at LED off condition, led display is back to the normal state.

2. Each MODE Display

1) Normal Mode Display

① Dial Display

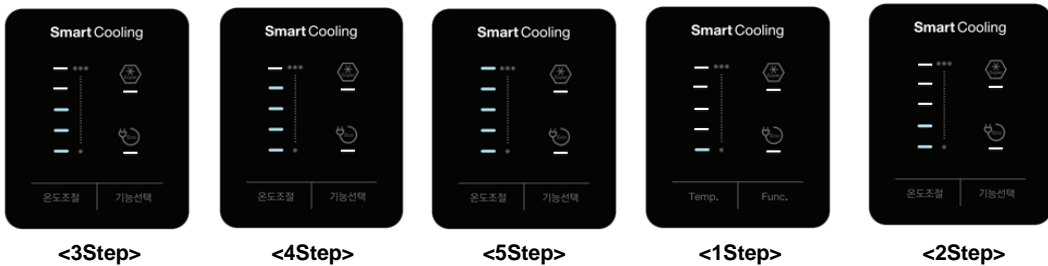

② Special Mode Display



7-3. Freezer Control

* The refrigerator is R-Control system. Freezer temperature is controlled by mechanical.

7-4. Refrigerator Control

Input	Output
<p>* Dial Type & Dial Inverter Type</p> <p>- volume dial knob</p> <p>* Fcp Type</p> <p>- Front PCB "Temp" Key</p>	- Refrigerator temperature

Dial Type & Dial Inverter Type

A. Refrigerator temperature setting (at 25°C)

Model	Temperature Adjust	1stpe	2stpe	3stpe	4stpe	5stpe	6stpe	7stpe
		Min				Mid		Max
240L	On Point (°C)	7.5	5.2	4.5	3.4	2.7	1.6	0.5
	Off Point (°C)	4.1	1.9	1.2	0.2	-0.6	-1.6	-2.7
34/36/400L	On Point (°C)	5.6	4.1	3.3	2.2	1.5	0.5	-0.2
	Off Point (°C)	2.3	0.8	0.1	-1.0	-1.7	-2.7	-3.4
48/510L	On Point (°C)	6.5	4.4	2.5	1.4	0.7	-0.4	-1.5
	Off Point (°C)	3.1	1.1	-0.8	-1.8	-2.6	-3.6	-4.7
13cu-ft	On Point (°C)	7.9	5.2	4.5	3.4	2.7	1.6	0.1
	Off Point (°C)	4.5	1.9	1.2	0.2	-0.6	-1.6	-3.1

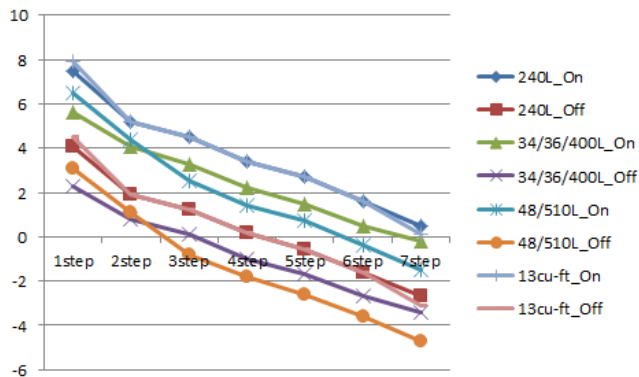

7-4. Refrigerator Control

Fcp Type

A. Dial Default Setting

- "3step"

B. Refrigerator temperature setting (at 25°C)

Model	Temperature Adjust	1step	2step	3step	4step	5step	Super
		Min		Mid		Max	Max
34/36/400L	On Point (°C)	5.6	3.3	1.5	0.5	-0.2	-0.2
	Off Point (°C)	2.3	0.1	-1.7	-2.7	-3.4	-3.4
48/510L	On Point (°C)	6.5	4.4	0.7	-0.4	-1.5	-1.5
	Off Point (°C)	3.1	1.1	-2.6	-3.6	-4.7	-4.7
13cu-ft	On Point (°C)	7.9	4.5	2.7	1.6	0.1	0.1
	Off Point (°C)	4.5	1.2	-0.6	-1.6	-3.1	-3.1

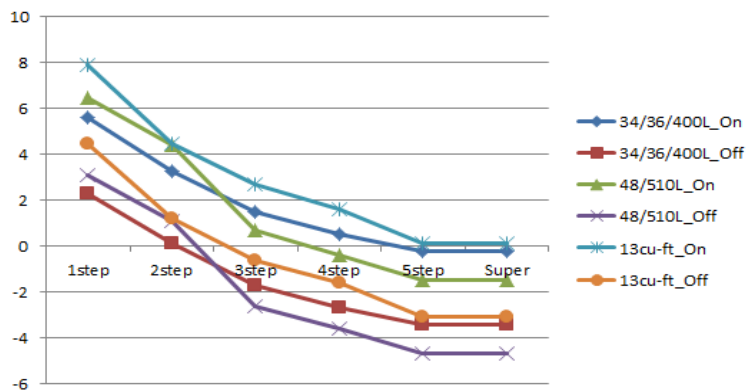

7-5. Special Mode Control

Input	Output
- "Func." Key	- Super Mode - Eco Mode

Fcp Type

A. Special Mode

- 1) Super Mode : For quickly cooling the fridge
- 2) Eco Mode : For saving the power

B. Special Mode Operation

- 1) Super Mode

Operation time	40 minutes
COMP	Continuously On / On, Off control

- 2) Eco Mode

Operation time	Unlimited
COMP	On, Off control

C. Special Mode Release

- 1) Super Mode

- after 40 minutes .

- 2) Eco Mode

- Unlimited

- If open the door within 30 minutes, the Eco Mode is released

7-6. Comp Control

Input	Output
<ul style="list-style-type: none"> - R-Sensor - Short Circuit / Defrost Mode - Elapsed time after comp off 	<ul style="list-style-type: none"> - Comp On/Off Operation

A. General Control

1) if Defrost Mode

Precool	Comp On
Heater On	Comp Off
Pause	Comp Off
Fan_Delay	Comp On

* compressor details operation sees chapter "Defrost Control".

2) if Normal Mode

① R-Sensor Error

- Compressor is controlled of the time by RT-Sensor's range.

② No R-Sensor Error

- Compressor is controlled of the setting On/Off point (reference 7-4)

- R-Sensor \leq Comp Off point \rightarrow Comp Off

- R-Sensor $>$ Comp On point \rightarrow Comp On

B. Prevention of Compressor Restart

- Compressor doesn't work within 6minutes after Compressor turns off. (This is to protect comp)

ex) Compressor doesn't work after COMP turns off even though R-sensor is on condition

7-7. Defrost Control

Input	Output
- RT / D-Sensor - Comp operation time / Real Time - Comp operation rate / Door Open Time	- Defrost Heater On/Off Operation

A. Initial Defrost

CONTENTS	EXPLANATION										
Inrush conditions	If the temperature at the D-sensor is under 3.5°C, Defrost Mode starts.										
	When D-Sensor Error is happened, the initial defrost function isn't performed .										
Each stage Release conditions	<table border="1"> <tr> <td>PreCool</td> <td>- Exception</td> </tr> <tr> <td rowspan="2">Heater On</td> <td>① D-Sensor > 13°C</td> </tr> <tr> <td>② after 60 minutes</td> </tr> <tr> <td>Pause</td> <td>- after 10 minutes</td> </tr> <tr> <td rowspan="2">Fan_Delay</td> <td>* Dial & Fcp Type – Exception</td> </tr> <tr> <td>* Dial Inverter Type - after 1 minute</td> </tr> </table>	PreCool	- Exception	Heater On	① D-Sensor > 13°C	② after 60 minutes	Pause	- after 10 minutes	Fan_Delay	* Dial & Fcp Type – Exception	* Dial Inverter Type - after 1 minute
	PreCool	- Exception									
	Heater On	① D-Sensor > 13°C									
		② after 60 minutes									
Pause	- after 10 minutes										
Fan_Delay	* Dial & Fcp Type – Exception										
	* Dial Inverter Type - after 1 minute										
Mode release	Auto closed after performing functions										

7-7. Defrost Control

B. Normal Defrost Mode

CONTENTS	EXPLANATION	
Inrush conditions	<p>① When total operation time of compressor becomes: 6, 8, 10, 12 hours.</p> <p>◆ Defrost conditions</p> <ul style="list-style-type: none"> i . Any Error happens - R1, D1, RT, dF, dr, F3, C1 Error ii . running rate of COMP (per 2hrs of total operation time) is more than 90%. iii. total door open time is over 2 minutes. <p>② Even if the above condition “Defrost conditions” is not satisfied,</p> <ul style="list-style-type: none"> i . Defrost mode starts immediately when total operation time of COMP is 14hrs. ii . defrost mode starts immediately as long as total time (COMP on time + COMP off time) is 72 hrs. 	
Each stage Release conditions	PreCool	<p>① R-Sensor > Comp Off Point - 3.0℃</p> <p>② after 25 minutes</p>
	Heater On	<p>case 1) D-Sensor Error - after 30 minutes</p> <p>case 2) RT-Mode is “Normal-B” & No open the door & running rate of comp is less than 80% - D-Sensor > 7℃</p> <p>case 3) if Comp Operating time is 6hours and the next Defrost</p> <ul style="list-style-type: none"> ① D-Sensor > 15℃ ② after 70 minutes <p>case 4) Else</p> <ul style="list-style-type: none"> ① D-Sensor > 13℃ ② after 60 minutes
	Pause	<p>case 1) if Comp Operating time is 6hours and the next Defrost - after 20 minutes</p> <p>case 2) Else - after 10 minutes</p>
	Fan_Delay	<p>* Dial & Fcp Type – Exception</p> <p>* Dial Inverter Type - after 1 minute</p>
Mode release	Auto closed after performing functions	

7-7. Defrost Control

C. Low Temp. Defrost Mode

CONTENTS	EXPLANATION	
Inrush conditions	When RT Mode is Low-A,B,	
	"Low Temp. defrost mode" starts immediately as long as total time (COMP on + off time) is 24 hrs.	
	◆ Mode Maintain conditions	
	i . RT Mode must maintain Low-A,B	
Each stage Release conditions	PreCool	① R-Sensor > Comp Off Point - 3.0℃
		② after 25 minutes
	Heater On	case 1) D-Sensor Error - after 30 minutes
		case 2) RT-Mode is "Normal-A" & No open the door - D-Sensor > 7℃
		case 3) Else
		① D-Sensor > 13℃
		② after 60 minutes
	Pause	- after 10 minutes
Fan_Delay	* Dial & Fcp Type – Exception	
	* Dial Inverter Type - after 1 minute	
Mode release	When RT Mode isn't low A, B, "Low Temp. defrost mode" is turned off immediately.	
	At Low Temp. Defrost Mode, normal defrost mode is performed by satisfying the normal conditions.	

D. High Temp. Defrost Mode

CONTENTS	EXPLANATION	
Inrush conditions	When RT Mode is High-A,B,	
	Defrost mode starts immediately when total operation time of COMP is 24hrs.	
	◆ Mode Maintain conditions	
	i . RT Mode must maintain High-A,B	
	ii . The door maintains closing.	
iii . No happened the Error		
Each stage Release conditions	PreCool	① R-Sensor > Comp Off Point - 3.0℃
		② after 25 minutes
	Heater On	① D-Sensor > 13℃
		② after 60 minutes
	Pause	- after 10 minutes
Fan_Delay	* Dial & Fcp Type – Exception	
	* Dial Inverter Type - after 1 minute	
Mode release	When the condition doesn't maintain, "High Temp. defrost mode" is turned off immediately.	
	If "High Temp. defrost mode" is released, normal defrost mode is performed.	

7-7. Defrost Control

* Defrost Flow

* General Defrost Flow

Defrost initial setting -> Precool -> Heater On -> Pause -> Fan_Delay -> Defrost end setting

I. Defrost initial setting

- Each check conditions are initialization.

II. Precool

- 1) Inrush conditions : after 'Defrost initial setting' completion.
- 2) Operation: Comp is On.

III. Heater On

- 1) Inrush conditions : aftr 'Precool' completion.
- 2) Operation : Defrost Heater On.

IV. Pause

- 1) Inrush conditions : after 'Heater On' completion
- 2) Operation : Comp, Defrost Heater Off

V. Fan_Delay

- 1) Inrush conditions : after 'Pause' completion.
- 2) Operation : Comp, C-Fan On

VI. Defrost end setting

- Each check conditions are initialization.

CONTENTS		Precool	HTR On	Pause	FAN Delay
Each stage Release conditions		Refer "Defrost Flow"			
Parts.	Comp, C Fan	On	off	Off	On
	F-Fan	On	off	Off	Off
	Defrost-HTR	Off	On	Off	Off

7-8. Buzzer Control

Input	Output
<ul style="list-style-type: none"> - Front key - Open the door more than 3 minute 	<ul style="list-style-type: none"> - Operate buzzer sound.

Fcp Type & Dial Inverter Type

A. At power on

- After 2 seconds power's on, the buzzer rings 3 times.(sound : bbi~ bbi~ bbi~)

B. Front Key

- Whenever "PCB Control Panel" button's pushed, the buzzer rings.(sound : bbi~ bi~)

C. Test mode entry

- Operate mode changing sound

Mode	Buzzer sound	
As Forced Defrost Mode	Entry	3 short beeps (sound : bbi bbi bbi)
	Release	No sound
Demo Mode	Entry	3 long beeps (sound : bbi~ bbi~ bbi~)
	Release	1 long beep (sound : bbi~~)
Jig Mode	Entry	1 short beep (sound : bbi)
	Release	3 long beeps (sound : bbi~ bbi~ bbi~)
Fine Adjustment Mode	Entry	3 long beeps (sound : bbi~ bbi~ bbi~)
	Release	1 long beep (sound : bbi~~)

D. Door Open Alarm

- When door opens for 3 minutes, the buzzer rings every 1 minute for 5 minutes. (sound : bbi bbi bbi)

7-9. Door Switch Control

Input	Output
- High / Low Signal	- Door Open / Closes State

A. F/R Door Switch

1) Door Open

- Door Open -> Door Switch On -> Micom Low (0V) signal Input.

2) Door Close

- Door Close -> Door Switch Off -> Micom High (5V) signal Input.

7-10. Lamp Control

Input	Output
- Door Open / Closes State - Lamp On Elapsed time	- Lamp On / Off Operation

A. F/R Lamp

1) Door Switch Error

- F/R Lamp is always off.

2) No Door Switch Error

① Door Open -> Lamp On, After 10 minutes, Lamp is forcibly off.

② Door Close -> Lamp Off.

Dial Type & Dial Inverter Type

*Exception) Line Defrost test Display

- This feature operates only within 120 minutes after the power is turned on.

- When A/S Forced Defrost Mode is entered, R-Lamp operates as follows

① Sensor Error -> R-Lamp is blinks for 30 seconds.

② No Sensor Error -> R-Lamp is forcibly on.

7-11. Cord Heater Control

Input	Output
- RT-Mode	- IL-Heater On / Off Operation

A. Cord-Heater Operation

1) Defrost Mode

- Always maintain the Off state.

2) Else

① RT-Mode is Low-A

- It is controlled by setting time.



Model	On time	Off time
48/510L	25 minutes	5 minutes
else	20 minutes	10 minutes

② RT-Mode is Low-B

- It is controlled by setting time.

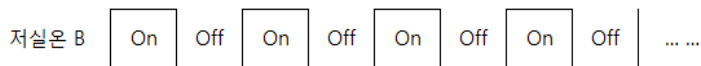

Model	On time	Off time
48/510L	15 minutes	15 minutes
else	15 minutes	15 minutes

③ The other RT-Mode and RT-Sensor Error

- Always maintain the Off state.

7-12. Function Switch Control (Main PCB Location)

Input	Output
- Test Switch - Time Switch	- Short Circuit / Power Saving / As Froced Defrost Mode selection. - Time Pass control

A. Test Switch

- Using Test Switch (Part No. SW2) in the Main PCB, short-circuit mode, the Power Saving mode, As forced defrost mode can be entered.

default	Test Switch 1 time	Test Switch 2 times	Test Switch 3 times
Short Circuit : Off	Short Circuit : On	Short Circuit : Off	Short Circuit : Off
Power Saving : Off	Power Saving : Off	Power Saving : On	Power Saving : Off
As forced defrost : Off	As forced defrost : Off	As forced defrost : Off	As forced defrost : On
Long beeps 3 times	Short beeps 1 time	Short beeps 2 time	Short beeps 3 time



* Pushing the Test Switch for 4 times, Test Mode is become default state.

B. Time Switch

- Using Test Switch (Part No. SW2) in the Main PCB, it can send forcedly the time.

① Short Click the Time Switch (within 1 second)

- 1 min : Click Time Switch one time on MAIN PCB.

② Push the Time Switch (more than 1 second)

- 30 min : If you press FAST KEY continuously, you can reduce 30 minutes on each 2.5 seconds with buzzer.

7-13. Mode Control

**Fcp Type can be entered the mode within 2 hours.
After 2 hours, The mode enterable environment is activated by pushing "TEMP + "FUNC" Key for 10 seconds.**

A. As Forced Defrost Mode

1) How to enter

① How to enter through Key Operation

* Dial Type & Dial Inverter Type

- by pressing "R-Door" switch for continuously and "Volume Dial" is rotated from 1 step to 7 step.

* Fcp Type

- by press "TEMP" button for continuously and "FUNC" button 5 times.

② How to enter through Main PCB Test Switch

- See part of the "Test Switch" in "Function Switch Control" Chapter.

2) Operation

- Process: same as General Defrost Mode except "PRE-COOL"

- Heater is on Initial 60 seconds even though the temp.

(for TEST)

CONTENTS		HTR On	Pause	Fan_Delay
Limited Time		60 minutes	10 minutes	1 minutes
Each stage Release conditions		1. Limited Time	Limited Time	Limited Time
		2. D-S > 13°C		
Parts.	Comp	Off	Off	On
	Defrost-HTR	On	Off	Off

3) Mode release : Auto closed after performing functions.

B. Short Circuit Test Mode

1) How to enter : See part of the "Test Switch" in "Function Switch Control" Chapter.

(It is available to restart the test and it'll be take 30 hours.)

2) Operation

- COMP & FAN will be on independent of the operating condition.

- There is no defrost mode on this test.

3) Mode release : after the limit test time 30 hours passes.

7-13. Mode Control

C. Error Display Mode

Dial Type & Dial Inverter Type

- 1) To confirm error happens or not, check LED on MAIN PCB
- 2) Operation

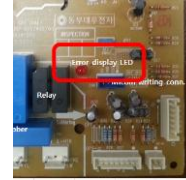

Priority	Error Code	Method to control
1	R1	Main PCB LED 1 time blink
2	RT	Main PCB LED 2 times blink
3	D1	Main PCB LED 3 times blink
4	dr	Main PCB LED 4 times blink
5	dF	Main PCB LED 5 times blink
6	F3	Main PCB LED 6 times blink

- 3) Mode release : Automatic reset become when all error codes return to normal condition.

Fcp Type

- 1) How to enter : by pressing "FUNC" button for continuously and "TEMP" button 5 times.
- 2) Operation

- To confirm error happens or not, check Display LED
- When No Error, Only Eco LED blink.

- ① R Sensor Open : Fridge Temperature Bar "1"step LED On
R Sensor Short : Fridge Temperature Bar "1"step LED Twinkle

- ② RT Sensor Open : Fridge Temperature Bar "2"step LED On
RT Sensor Short : Fridge Temperature Bar "2"step Twinkle

- ③ D Sensor Open : Fridge Temperature Bar "3"step On
D Sensor Short : Fridge Temperature Bar "3"step Led Twinkle

- ④ F Door Error : Fridge Temperature Bar "4"step Led On

- ⑤ R Door Error : Fridge Temperature Bar "5"step Led On

- ⑥ Cycle Error : Super Led On

- ⑦ Return Defrost Error : Super Led Twinkle

- 3) Mode release : Push "FUNC" 1 time.

Display	고장 증상
Fridge Temperature Bar "1"step LED On	R Sensor Open
Fridge Temperature Bar "1"step LED Twinkle	R Sensor Short
Fridge Temperature Bar "2"step LED On	RT Sensor Open
Fridge Temperature Bar "2"step LED Twinkle	RT Sensor Short
Fridge Temperature Bar "3"step LED On	D Sensor Open
Fridge Temperature Bar "3"step LED Twinkle	D Sensor Short
Fridge Temperature Bar "4"step LED On	F Door Error
Fridge Temperature Bar "5"step LED On	R Door Error
Super LED On	Cycle Error
Super LED Twinkle	Return Defrost Error

7-13. Mode Control

Fcp Type

D. Fine Adjustment Mode

1) How to enter : by pressing "TEMP" buttons for 10 seconds.

2) Operation

- When enter the mode, Only Super LED blink

- On / Off point is varied by fine adjustment value.

DISPLAY	Eco	Fridge Temperature Bar					fine adjustment value
		"1"step	"2"step	"3"step	"4"step	"5"step	
LED ON/OFF							-5
							-4
							-3
							-2
							-1
							0
							1
							2
							3
							4
							5



: LED On

: LED OFF

3) Mode release : When it passes 5seconds without key operation, auto closed the mode.

E. Demo Mode

1) How to enter : by pressing "FUNC" buttons for 10 seconds.

2) Operation

- All electronic compartments are off except "Display Panel".

- "1"step -> "2"step -> "3"step -> "4"step -> "5"step -> Super -> Eco -> All Led Off

- When "DEMO" mode works, led lamps will be on as next steps.

3) Mode release : by pressing "FUNC" buttons for 10 seconds

7-14. Control of R-sensor OFF Point

Input	Output
- J1, J2 On Main PCB	- Control Resistance of R sensor OFF Point

A. LOW COOLING OPTION

(1) Adjust R-Sensor off point (Max 3.0deg down)

(2) the following actions are recommended for service.

- ① Resistance (R52) : Default resistance (31.4Kohms)
- ② Resistance (R53) : Cut the "J1" off to reduce basic resistance by 1.5°C. (2KΩ up)
- ③ Resistance (R54) : Cut the "J2" off additionally to reduce basic resistance by 1.5°C. (total 4KΩ up)

ex) $R52 = \text{R-SENSOR OFF point}$

$R52 + R53 = \text{R-SENSOR OFF point} - 1.5^{\circ}\text{C}$

$R52 + R53 + R54 = \text{R-SENSOR OFF point} - 3^{\circ}\text{C}$

Dial Type

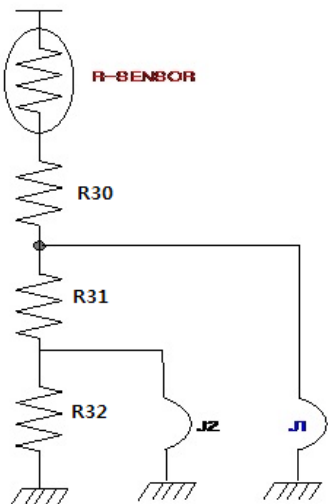

Fcp Type & Dial Inverter Type

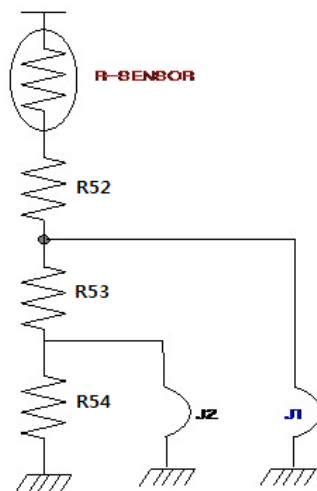

7-15. Error Code

A. R-Sensor Error

- 1) Error Code : R1
- 2) Condition :
 - ① R-Sensor Open : It happens when R-Sensor is sensing less than -45°C
 - ② R-Sensor Short : It happens when R-Sensor is sensing more than 50°C
- 3) release : When R-Sensor is sensing from -45 to 50°C .

B. RT-Sensor Error

- 1) Error Code : Rt
- 2) Condition :
 - ① RT-Sensor Open : It happens when RT-Sensor is sensing less than -45°C
 - ② RT-Sensor Short : It happens when RT-Sensor is sensing more than 50°C
- 3) release : When RT-Sensor is sensing from -45 to 50°C .

C. D-Sensor Error

- 1) Error Code : D1
- 2) Condition :
 - ① D-Sensor Open : It happens when D-Sensor is sensing less than -45°C
 - ② D-Sensor Short : It happens when D-Sensor is sensing more than 50°C
- 3) release : When D-Sensor is sensing from -45 to 50°C

D. R-Door Error

- 1) Error Code : dr
- 2) Condition : It happens when the system senses R-Door opens more than 1 hour
- 3) release : If R-Door switch (close) is sensed, the error is terminated automatically

E. F-Door Error

- 1) Error Code : dF
- 2) Condition : It happens when the system senses F-Door opens more than 1 hour
- 3) release : If F-Door switch (close) is sensed, the error is terminated automatically

F. Cycle Error

- 1) Error Code : C1
- 2) Condition : When D-Sensor is more than -5°C , Comp operates over 3 hours
- 3) release : When Comp is off, D-Sensor is less than -5°C .

* When D-Sensor is normal operation, "C1" Error can be checked.

G. Return Defrost Error

- 1) Error Code : F3
- 2) Condition : Return to next limit defrost time.
- 3) release : Completion of defrost returned by D-Sensor.

* When D-Sensor is normal operation, "F3" Error can be checked.

7-16. Sensor Table

1. R, D, RT Sensor Table

TEMP(°C)	MIN (Kohm)	MEAN (Kohm)	MAX (Kohm)	Resistance Tolerance(%)	Temp Tolerance(%)
-30	-124.72	130.48	136.38	4.525	0.84
-25	95.942	100.11	104.36	4.249	0.814
-20	74.425	77.458	80.542	3.982	0.788
-15	58.197	60.418	62.668	3.724	0.761
-10	45.858	47.494	49.144	3.474	0.733
-5	36.402	37.612	38.828	3.233	0.703
0	29.1	30	30.9	3	0.673
5	23.319	24.093	24.87	3.226	0.747
10	18.81	19.476	20.147	3.446	0.822
15	15.271	15.844	16.424	3.66	0.899
20	12.473	12.967	13.469	3.868	0.979
25	10.248	10.675	11.11	4.07	1.061
30	8.4682	8.8375	9.2145	4.267	1.145
35	7.0353	7.3556	7.6835	4.458	1.232
40	5.8755	6.154	6.4398	4.645	1.32
45	4.9317	5.1743	5.4241	4.826	1.411

2. F Sensor Table

TEMP(°C)	MIN (Kohm)	MEAN (Kohm)	MAX (Kohm)	Resistance Tolerance(%)	Temp Tolerance(%)
-30	37.402	39.657	41.942	5.763	0.971
-25	28.021	29.618	31.228	5.436	0.947
-20	21.192	22.333	23.477	5.122	0.922
-15	16.118	16.995	17.875	5.179	0.964
-10	12.339	13.046	13.76	5.47	1.051
-5	9.5266	10.1	10.68	5.75	1.141
0	7.4154	7.8816	8.3561	6.021	1.233
5	5.8173	6.1983	6.5876	6.282	1.328
10	4.5979	4.9106	5.2316	6.535	1.425
15	3.6603	3.9182	4.1839	6.78	1.525
20	2.9341	3.1478	3.3687	7.017	1.627
25	2.3676	2.5455	2.73	7.246	1.732
30	1.9227	2.0715	2.2262	7.469	1.84
35	1.5711	1.696	1.8264	7.684	1.95
40	1.2913	1.3968	1.507	7.894	2.063
45	1.0675	1.1568	1.2505	8.097	2.179

7-16. Constraint

A. H/W Constraint

- According to the local environment and Micom Spec, hardware function can be constrained.

B. S/W Constraint

- Depending on the amount of memory and CPU performance may be different from the S / W performance results
- When operating with other and different applications, it may be deteriorated.

EXPLODED VIEW & PART LIST
A > CABINET

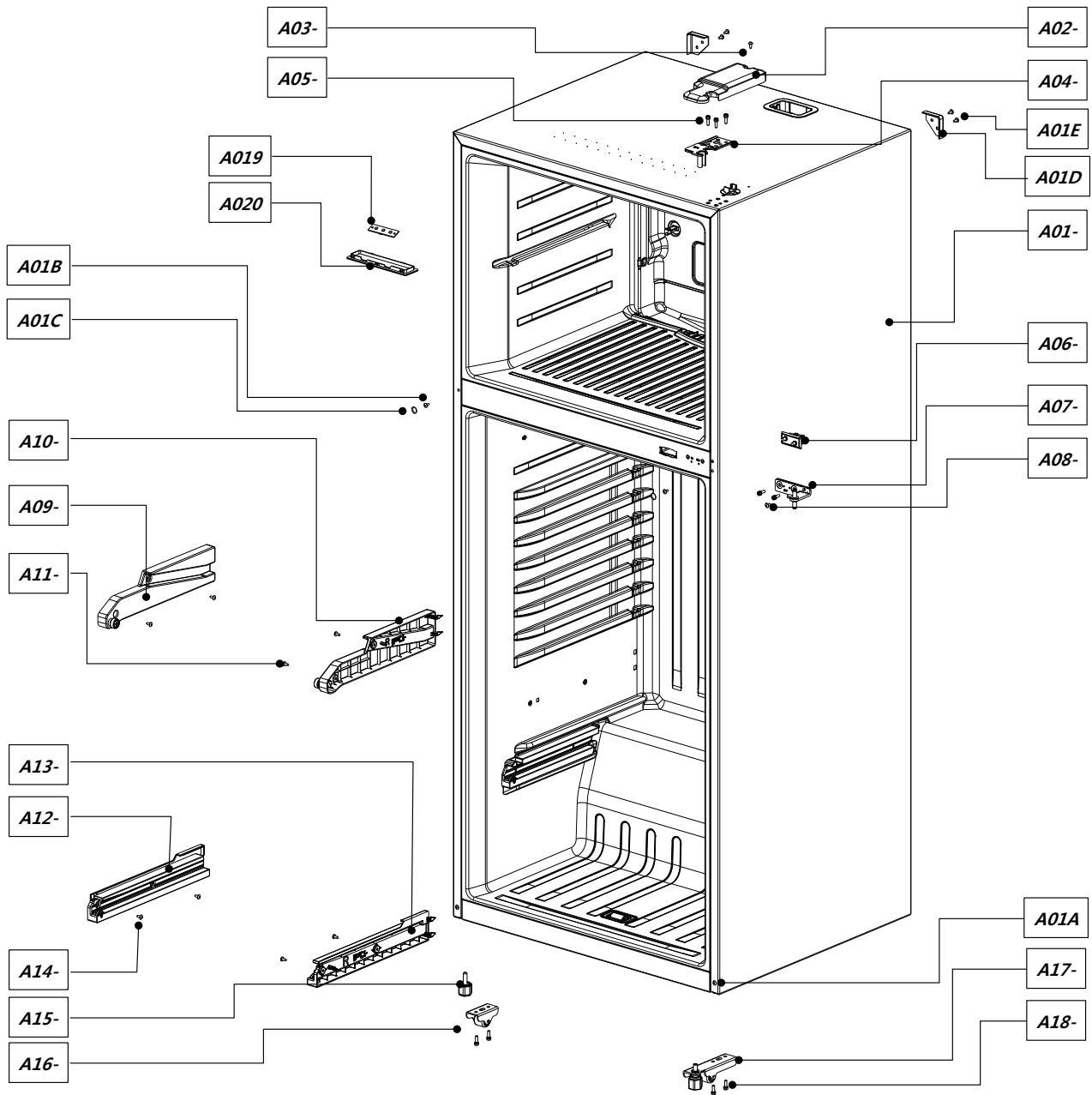

EXPLODED VIEW & PART LIST
B > MECH ROOM

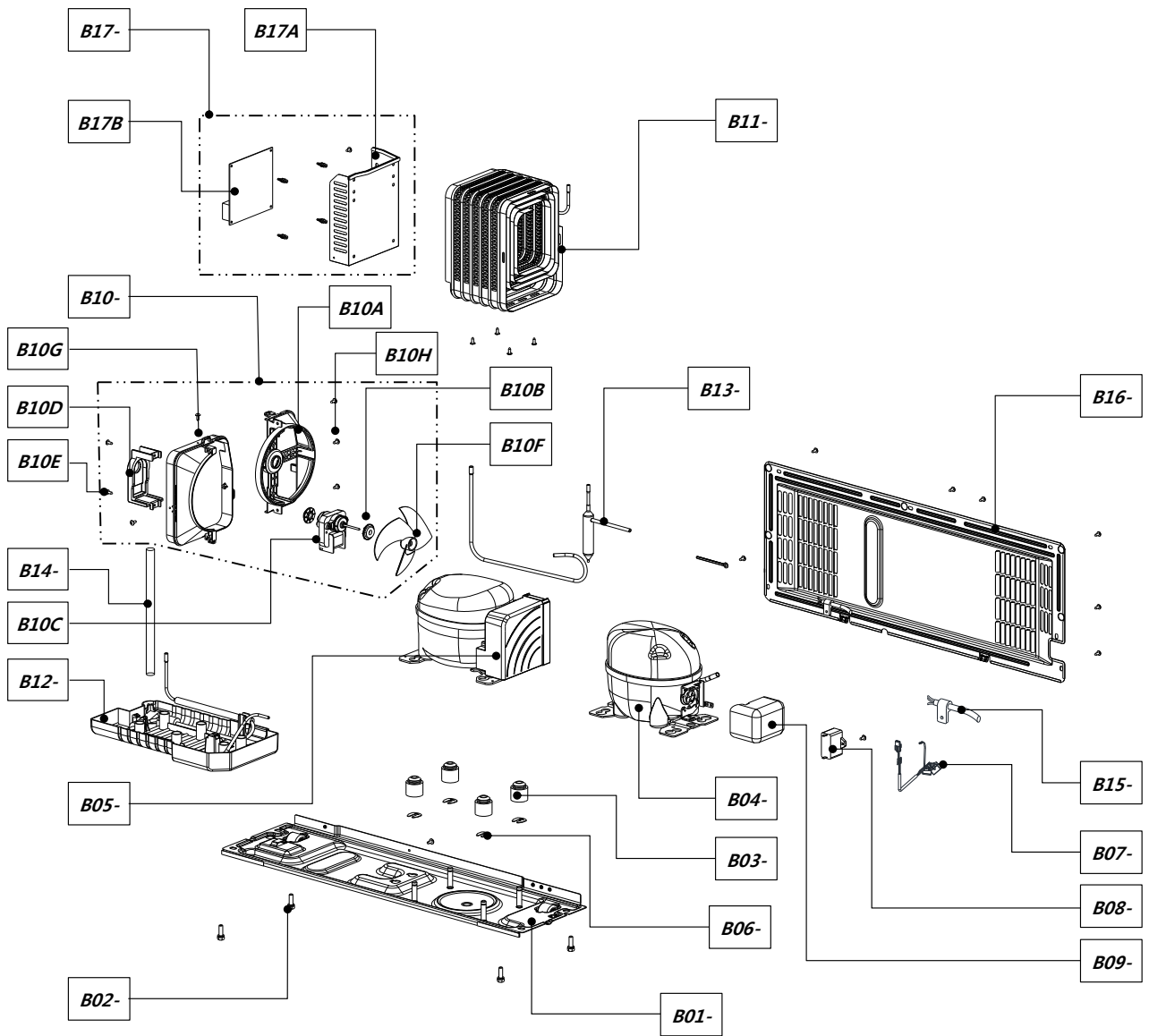

EXPLODED VIEW & PART LIST

C> EVAPORATOR AS / LOUVER F AS

D> COVER M/F DUCT AS

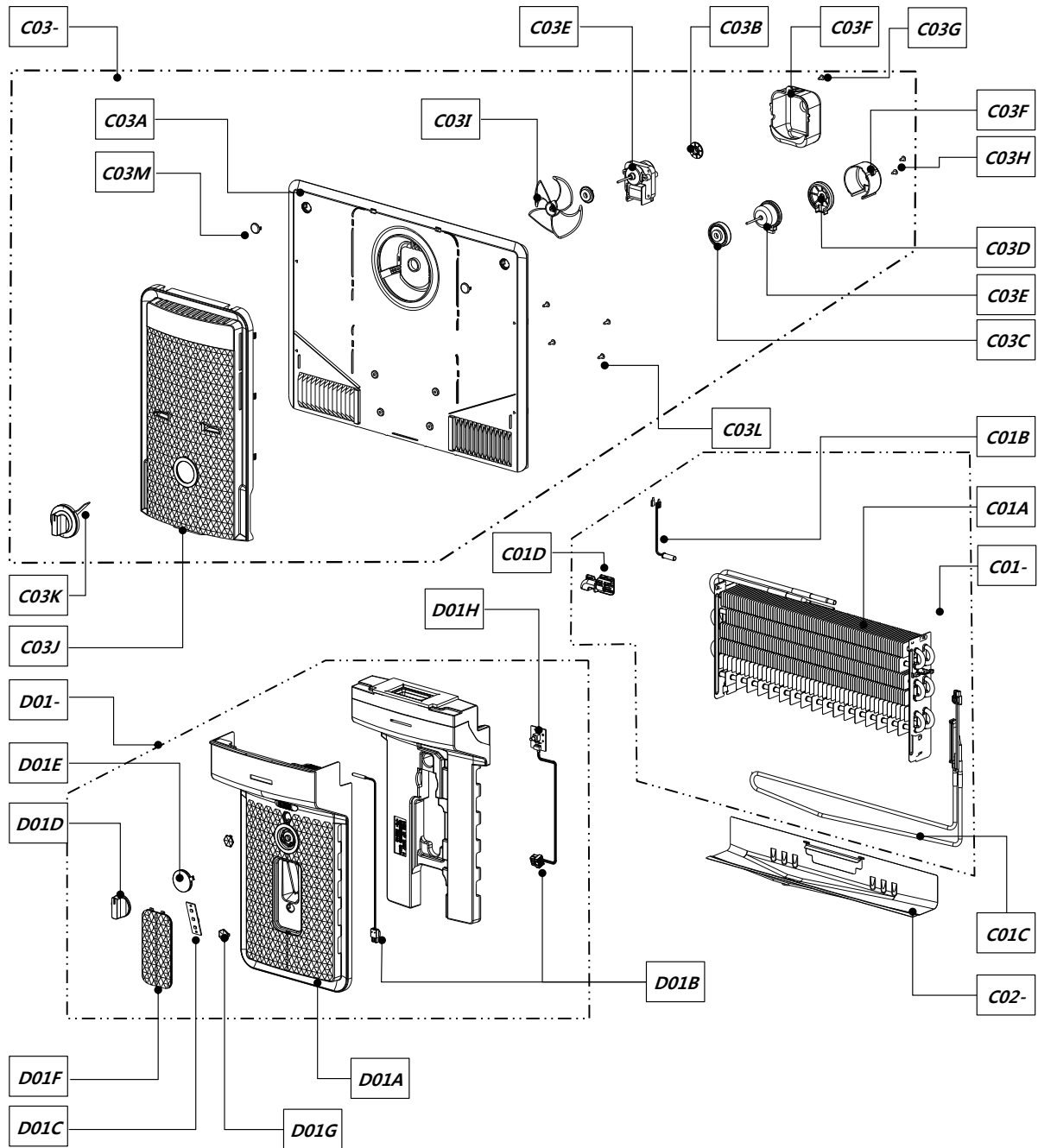

EXPLODED VIEW & PART LIST

E> FREEZER COMPARTMENT

F> REFRIGERATOR COMPARTMENT

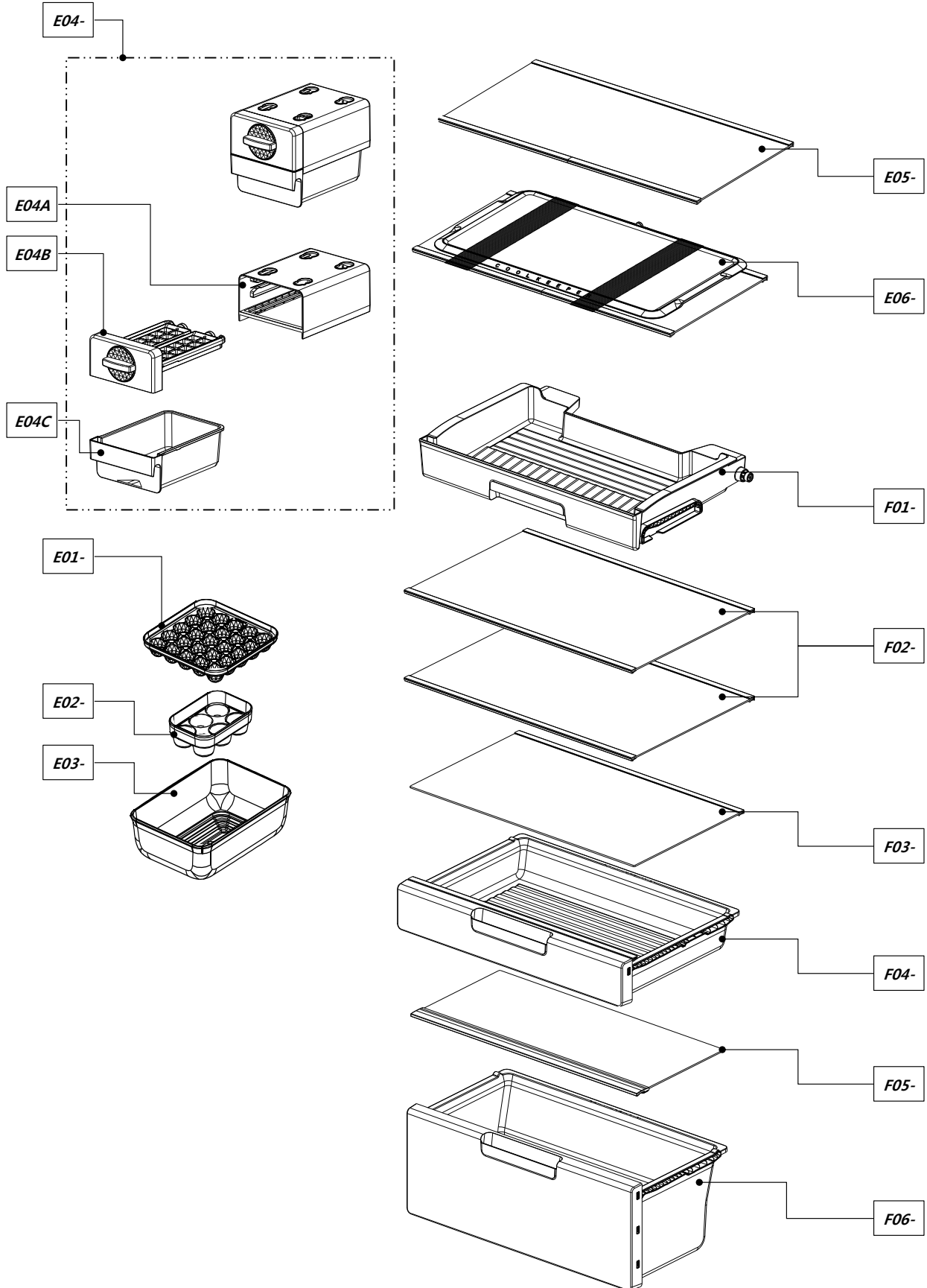

EXPLODED VIEW & PART LIST

G> FREEZER DOOR

H> REFRIGERATOR DOOR

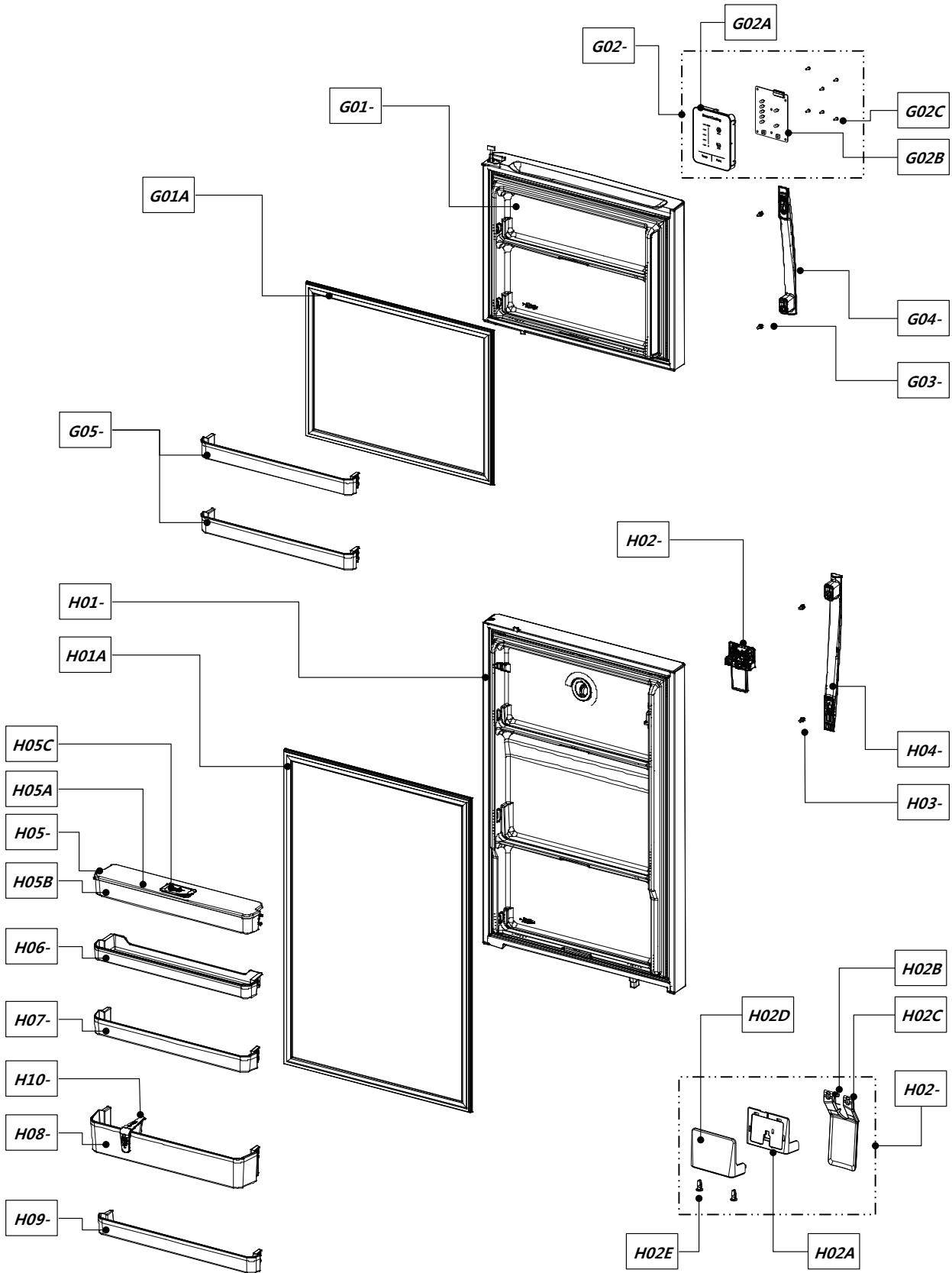

Parts List (Model : RGE 480 / 510)

NO	PART-CODE	PART NAME	SPEC.	Qty				Remark			
				RGE 480	RGP 480	RGE 510	RGP 510				
A> CABINET											
A	0	1	-	-	ASSY CAB URT	RGP48	1	1	-	-	
				-		RGE51	-	-	1	1	
A	0	1	A	7112401211	SCREW TAPPING	T1 TRS 4*12 MFZN	3	3	3	3	
A	0	1	B	4004Q75204	SPECIAL SCREW AS	SCREW AS	2	2	2	2	
A	0	1	C	3010903200	CAP SCREW	PE-LD WHI304A	2	2	2	2	
A	0	1	D	3010968400	CAP CAB COVR	PP	2	2	2	2	
A	0	1	E	7112401211	SCREW TAPPING	TRS 4*12 MFZN	4	4	4	4	
A	0	2	-	3001445400	COVER HI *T	PP J-370A,FRP-512	1	1	1	1	
A	0	3	-	3016003400	SPECIAL BOLT	SPECIAL BOLT T1 M5.0X14	1	1	1	1	
A	0	4	-	3012935400	HINGE *T AS	SHP1 2.6T, FPR-512	1	1	1	1	
A	0	5	-	3016001250	SPECIAL BOLT *M	M6*15 SWCH22A	3	3	3	3	
A	0	6	-	3018100010	SWITCH DR	2 BUTTON/4P,DSD-5	1	1	1	1	
A	0	7	-	30129-0017800-01	HINGE *M AS	HINGE *M AS RGE48	1	1	1	1	
A	0	8	-	3016001250	SPECIAL BOLT *M	M6*15 SWCH22A	2	2	2	2	
A	0	9	-	30125-0034000-00	GUIDE U/C *L AS	FRP-512, GUIDE+ROLLER	1	1	1	1	option
A	1	0	-	30125-0034100-00	GUIDE U/C *R AS	FRP-512, GUIDE+ROLLER	1	1	1	1	option
A	1	1	-	7122401611	SCREW TAPPING	T2S TRS 4X16 MFZN	4	4	4	4	option
A	1	2	-	30125-0035100	GUIDE F/C *L AS	AS	1	1	1	1	option
A	1	3	-	30125-0035200	GUIDE F/C *R AS	AS	1	1	1	1	option
A	1	4	-	7122401611	SCREW TAPPING	T2S TRS 4X16 MFZN	4	4	4	4	option
A	1	5	-	3012107000	FOOT ADJ AS	PP	1	1	1	1	
A	1	6	-	30165-0002000-00	CASTER *F AS	RGE48	1	1	1	1	
A	1	7	-	3012941900	HINGE *U AS	SPHC T3.0	1	1	1	1	
A	1	8	-	3016003300	SPECIAL BOLT	M6.5*20	4	4	4	4	
A	1	9	-	30136A1600	LAMP LED AS	3LED,66*20*1.6T,DC12V	1	1	1	1	option
A	2	0	-	3015531000	WINDOW F LAMP	GPPS	1	1	1	1	option
B> MECH ROOM											
B	0	1	-	30103-0028700-00	BASE COMP AS	AS	1	1	1	1	
B	0	2	-	3016003300	SPECIAL BOLT	T2 M6.5*20	4	4	4	4	
B	0	3	-	3010101430	ABSORBER COMP	NBR	4	4	4	4	R-134A
				3010101480	ABSORBER COMP AS	FRU-541D					R-600A
				39561U/C6A		LJ118DY(220V 60 Hz)	1	1	1	1	R-600A
B	0	4	-	60110-0009500-00	COMPRESSOR	LJ126CY (220~240V 50Hz),	1	1	1	1	R-600A
				3959100100		BMA069LAMV LG	1	1	1	1	R-134A
B	0	5	-	3814301000	COMP BOX INVERTER AS	AS	1	1	1	1	
B	0	6	-	3016002520	WASHER COMP	T0.8*W19*L19.5	4	4	4	4	
B	0	7	-	60181-0010700-00	SWITCH P RELAY AS	220V/60Hz	1	1	1	1	
				60181-0010800-00		230V/50Hz	1	1	1	1	
B	0	8	-	3016407040	CAPACITOR RUN (R/C)	450V,4UF(WIRE HOUSING,CQC)	1	1	1	1	
B	0	9	-	3811402600	COVER RELAY	COVER RELAY	1	1	1	1	
				30185-0002000-00		220V/60Hz	1	1	1	1	
				30185-0002001-00	M/BELL AS	230V/50Hz	1	1	1	1	
				30185-0002003-00		DC 12V	1	1	1	1	
B	1	0	A	3018501600	M/BELL A1	PP	1	1	1	1	
B	1	0	B	3010107100	ABSORBER F MOTOR	ABSORBER F MOTR NBR	2	2	2	2	
				3015925800		220V/60Hz	1	1	1	1	
				3015925400	MOTOR C FAN	230V/50Hz	1	1	1	1	
				60159-0010900-00		DC 12V	1	-	1	-	
B	1	0	D	3012049100	FIXTURE MOTR	PP	1	1	1	1	
B	1	0	E	7122401011	SCREW TAPPING	TRS 4*10 MFZN	2	2	2	2	
B	1	0	F	3011834510	FAN AS	FAN OD130, ABS	1	1	1	1	
B	1	0	G	3018501700	M/BELL A2	PP	1	1	1	1	
B	1	0	H	7122401011	SCREW TAPPING	TRS 4*10 MFZN	2	2	2	2	
B	1	1	-	60144-0025300-00	PIPE WICON AS	AS	1	1	1	1	
B	1	2	-	30111-0041900-00	CASE VAPORI AS	AS	1	1	1	1	
B	1	3	-	60168-0001600-00	DRYER AS	10G, SINGLE TUBE	1	1	1	1	
B	1	4	-	3012513960	HOSE DRN A2	PVC	1	1	1	1	
				3011350800		GPF, EU(LP-33)	1	1	1	1	
				60113-0006603-00	CORD POWER AS	GPF LP-61L, 250V 13A	1	1	1	1	
				60113-0006604-00		GPF LP-33, 250V 16A	1	1	1	1	
				60113-0006606-00		GPF PJT, TAIWAN 125V 7A	1	1	1	1	
B	1	6	-	30114-0076900-00	COVER MACH RM AS	AS	1	1	1	1	
				30105-0030100-00		NO FCP TYPE	1	-	1	-	
				30105-0030101-00	BOX M/PCB AS	FCP TYPE	-	1	-	1	
				30105-0030102-00		INVERTER TYPE	1	1	1	1	
B	1	7	A	3010591300	BOX M/PCB	SGCC 0.4T	1	1	1	1	
				40301-0060200-00		NO FCP TYPE	1	-	1	-	
				40301-0060100-00	PCB MAIN ASSY	FCP TYPE	-	1	-	1	
				40301-0067801-00		INVERTER TYPE	1	1	1	1	

Parts List (Model : RGE 480 / 510)

NO	PART-CODE	PART NAME	SPEC.	Qty				Remark			
				RGE 480	RGP 480	RGE 510	RGP 510				
NO	PART-CODE	PART NAME	SPEC.	Qty				Remark			
				RGE 480	RGP 480	RGE 510	RGP 510				
C> EVAPORATOR AS / LOUVER F AS											
C	0	1		60170-0008500-00	EVA AS	230V	1	1	1	1	
				60170-0008501-00		110V	1	1	1	1	
C	0	1	A	60170-0008600-00	EVA SAS	AS	1	1	1	1	
C	0	1	B	3014813800	SENSOR DEFR AS	SENSOR D AS R13E10B0FDNMX4	1	1	1	1	
C	0	1	C	60128-0010900-00	HEATER SHEATH AS	230V 200W RGE48	1	1	1	1	
				60128-0010901-00		110V 185W RGE48/51	1	1	1	1	
C	0	1	D	3012050300	FIXTURE DEFR SENS	PP	1	1	1	1	
C	0	2	-	3012559300	GUIDE DRN	GL T0.3X615X240	1	1	1	1	
C	0	3	-	30189-0012100-00	LOUVER F AS	220V/60Hz	1	1	1	1	
				30189-0012101-00		230V/50Hz	1	1	1	1	
				30189-0013100-00		DC 12V RGE48	1	1	1	1	
C	0	3	A	3018934900	LOUVER F	PP	1	1	1	1	
C	0	3	B	3010107100	ABSORBER F MOTR	ABSORBER F MOTOR NBR	2	2	2	2	
C	0	3	C	3010146200	ABSORBER MOTR F DC	SILICON	1	1	1	1	
C	0	3	D	3010146300	ABSORBER MOTR B DC	SILICON	1	1	1	1	
C	0	3	E	3015925500	MOTOR F FAN	220V/60Hz	1	1	1	1	
				3015925100		230V/50Hz	1	1	1	1	
				60159-0010800-00		(DREP8020LB) 12V 1.35W 2000rpm	1	1	1	1	
C	0	3	F	3012049300	FIXTURE MOTR *B	AC용	1	1	1	1	
				3012049400		DC용	1	1	1	1	
C	0	3	G	7112401211	SCREW TAPPING	T1 TRS 4*12	1	1	1	1	AC용
C	0	3	H	7112401211	SCREW TAPPING	T1 TRS 4*12	2	2	2	2	DC용
C	0	3	I	3011802700	FAN AS	FAN(OD110)+CLAMP	1	1	1	1	
C	0	3	J	30114-0076800-00	COVER F FAN PR	SILK PRINT	1	1	1	1	
				30114-0076801-00		SILK PRINT , 대만항	1	1	1	1	
C	0	3	K	3013417800	KNOB F CONTL	HIPS	1	1	1	1	
C	0	3	L	7112401211	SCREW TAPPING	T1 TRS 4*12	4	4	4	4	
C	0	3	M	3010924600	CAP F LUVR	HIPS T2.3	2	2	2	2	
D> COVER M/F DUCT AS											
D	0	1	-	30114-0076600-00	COVER M/F DUCT AS	RGE48, 51, NO FCP TYPE	1	-	1	-	
				30114-0076601-00		RGP48,51, FCP TYPE	-	1	-	1	
D	0	1	A	30114-0076700-00	COVER M/F DUCT PR	PP	1	1	1	1	
D	0	1	B	60127-0037800-00	HARNESS M/F DUCT AS	RGE48, 51, NO FCP TYPE	1	-	1	-	
				60127-0037801-00		RGP48,51, FCP TYPE	-	1	-	1	
D	0	1	C	30136A1600	LAMP LED AS	LED-3, 66X20X1.6T, DC12V	1	1	1	1	
D	0	1	D	3013417900	KNOB R CONTL	RGE48, 51, NO FCP TYPE	1	-	1	-	
D	0	1	E	30109-0045500-00	CAP KNOB R CONTL	RGE48,51, FCP TYPE	-	1	-	1	
D	0	1	F	3015530Z00	WINDOW R LAMP	GPPS	1	1	1	1	
D	0	1	G	301099Z500	CAP M/F DUCT	HIPS	2	2	2	2	
D	0	1	H	30143KW260	PCB ASSY	BALLISTA VOLUME	1	-	1	-	
E> Freezer Compartment											
E	0	1	-	301119ZJ00	CASE ICE	PP CASE ICING(TRAY)	1	1	1	1	option
E	0	2	-	301119ZD00	CASE EGG	PP	1	1	1	1	option
E	0	3	-	301119ZH00	CASE ICE	PP MULTI BOX	1	1	1	1	option
E	0	4	-	30104-0002200-00	BODY I/MAKER AS	AS	1	1	1	1	option
E	0	4	A	3010405400	BODY I/MAKER	HIPS	1	1	1	1	option
E	0	4	B	3012258300	FRAME I/MAKER AS	AS	1	1	1	1	option
E	0	4	C	30105-0029800-00	BOX I/MAKER AS	SILK PRINT	1	1	1	1	option
E	0	5	-	30178-0025300-01	SHELF F GLAS AS	AS	1	1	1	1	option
				30178-0025301-01		FILM	1	1	1	1	option
E	0	6	-	30178-0027700-00	SHELF F I/PACK AS	SHELF(FILM),I/PACK	1	1	1	1	option
F> Refrigerator Compartment											
F	0	1	-	30111-0042100-00	CASE UTILITY AS	SILK PRINT	1	1	1	1	option
				30111-0042101-00		SILK PRINT+HOTSTAMPING	1	1	1	1	option
F	0	2	-	30178-0025100-01	SHELF R GLAS AS	AS	2	2	2	2	option
				30178-0025101-01		FILM	2	2	2	2	option
F	0	3	-	30178-0027600-00	SHELF FC GLASS AS	AS	1	1	1	1	option
				30178-0027601-00		FILM	1	1	1	1	option
F	0	4	-	30111-0043700-00	CASE FRESH AS	SILK PRINT	1	1	1	1	option
				30111-0043701-00		SILK PRINT+HOTSTAMPING	1	1	1	1	option
F	0	5	-	30178-0025200-00	SHELF V/CASE AS	AS	1	1	1	1	
F	0	6	-	30111-0042000-00	CASE VEGETB AS	SILK PRINT	1	1	1	1	option
				30111-0042001-00		SILK PRINT+HOTSTAMPING	1	1	1	1	option

